









GRENBERT



**Two-Piece Type
Hose Fittings**

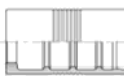

G-Series and P-Series

FERRULE







N5300 	N5400 	N8000 	S8000-SM 	S8900 
D6	D7	D8	D8	D9
S9000 	S9000L 	FTH7/8 		
D9	D10	D10		

G AND P SERIES



NPT / NPSM

MP - Male 	MPX - Male Swivel 	FP - Female Swivel 
D11	D12	D12

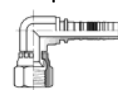

JIC 37° FLARE

MJ - Male 	FJ - Female 	FJC - Female (Single HEX) 	FJ45 - Female 45° Elbow 	FJ90 - Female 90° Elbow 
D13	D14	D15	D16	D17
FJ90L - Female 90° Elbow Long Drop 	FJ90 - Female 90° Elbow Short Drop 			
D18	D19			





O-RING BOSS

MOB - Male 	MOBX - Male Swivel 
D20	D20

SAE 45 FLARE

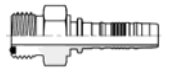

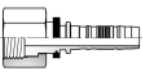
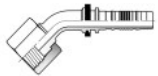







FS - Female 	FS90 - Female 90° Elbow 
D21	D21

FLAT FACE O-RING

MF - Male 	FF - Female 	FFC - Female (Single HEX) 	FF45 - Female 45° Elbow 	FF90 - Female 90° Elbow 
D22	D23	D24	D25	D26
FF90 - Female 90° Elbow Long Drop 				
D27				







G AND P SERIES

SAE CODE 61 FLANGES



FL  D28	FL22.5 – 22.5° Elbow  D29	FL30 – 30° Elbow  D30	FL45 – 45° Elbow  D31	FL45L – 45° Elbow Long Drop  D32
FL60 – 60° Elbow  D33	FL67.5 – 67.5° Elbow  D34	FL90 – 90° Elbow  D35	FL90L – 90° Elbow Long Drop  D36	FL110 – 110° Elbow  D37
FL135 – 135° Elbow  D37				

PART D
G/P Series



SAE CODE 62 FLANGE

FLH  D38	FLH22.5 – 22.5° Elbow  D40	FLH45 – 45° Elbow  D38	FLH45L – 45° Elbow LONG DROP  D39	FLH67.5 – 67.5° Elbow  D40
FLH90 – 90° Elbow  D41	FLH90L – 90° Elbow Long Drop  D42			

CATERPILLAR FLANGE



FLC  D43	FLC45 – 45° Elbow  D43	FLC90 – 90° Elbow  D44
---	---	---

HT SERIES – SAE62 FLANGE (EXTREME HIGH PRESSURE – HIGH IMPULSE)

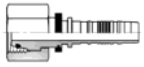

FLH  D45	FLH45 – 45° Elbow  D45	FLH90 – 90° Elbow  D46
---	---	---

G AND P SERIES





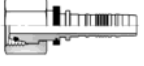

METRIC DIN 24° CONE L-SERIES

MDKOL – Male 	FDKOL – Female 	FDKOL45 - 45° Elbow 	FDKOL90 - 90° Elbow 
D47	D48	D49	D50



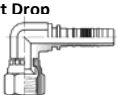

METRIC DIN 24° CONE S-SERIES

MDKOS – Male 	FDKOS – Female 	FDKOS45 - 45° Elbow 	FDKOS90 - 90° Elbow 
D51	D52	D53	D54



BRITISH PIPE THREAD (BSPP / BSPT)

MT – BSPT Male 	MB – BSPP Male 	FBH – BSPP Female 	FB – BSPP Female 	FB45 – BSPP 45° Elbow 
D55	D56	D56	D57	D58
FB90 – BSPP 90° Elbow 	FB90S -BSPP 90° Elbow Short Drop 			
D59	D60			

METRIC 30° FLARE (KOMATSU)

FK – Female 	FKC – Female (Single HEX) 	FK45 - 45° Elbow 	FK90 - 90° Elbow 
D61	D62	E63	E64



JAPAN 30° FLARE PARALLEL THREAD (JIS)

FJIS – Female 	FJIS45 - 45° Elbow 	FJIS90 - 90° Elbow 
D65	D66	D67

METRIC 45° FLARE (AIR BRAKE)

MA - Male 
D68

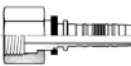
METRIC O-RING FACE SEAL

MAM - Male 	FA – Female 	FA90 - 90° Elbow 
D68	D69	D70

G AND P SERIES

METRIC 24° CONE (KOBELCO)

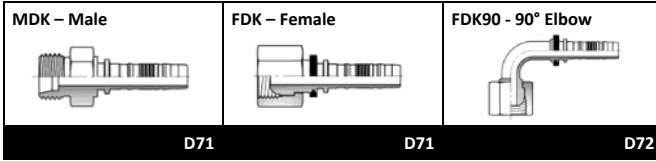

METRIC BALL NOSE

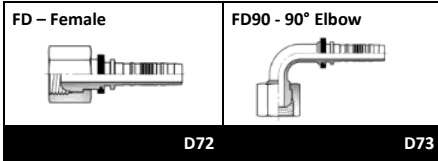

METRIC BANJO

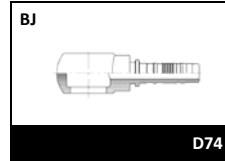

HOSE CONNECTOR

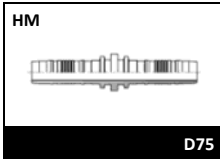

WELD FITTING

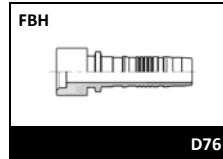

PUSH-LOK FITTINGS

PUSH-LOK FITTING

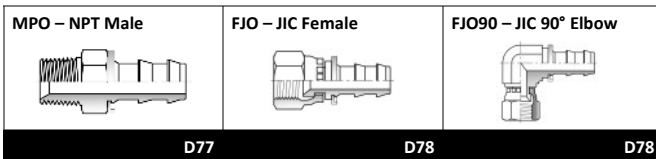

N5300 FERRULE (NON-SKIVE BRAIDED HOSE)

Features

Matching Insert : G-Series Insert

Non-Skive

Hose Type: 1SN,1SC,2SC,R16,R17

For Hose OD below “d” value

Material : Carbon Steel, Stainless Steel

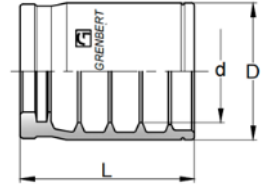

Part Number	Hose Size		d mm	D mm	L mm
	Inch	mm			
N5300 FERRULE					
N5300-04	1/4	6.4	14.3	20	27
N5300-05	5/16	7.9	15.5	21.5	27
N5300-06	3/8	9.5	18.3	24.5	30
N5300-08	1/2	12.7	21.5	28	32.5
N5300-10	5/8	15.9	25	32	35
N5300-12	3/4	19	28.8	36	40
N5300-16	1	25.4	37	45	50
N5300-20	1.1/4	31.8	45	54	50
N5300-24	1.1/2	38.1	52.5	62	55
N5300-32	2	50.8	65.6	76	60

N5400 FERRULE (NON-SKIVE BRAIDED HOSE)

Features

Matching Insert : G-Series Insert

Non-Skive

Hose Type: 2SN,R2, STRARA AC 2 wires

For Braided Hose OD below “d” value

Material : Carbon Steel, Stainless Steel

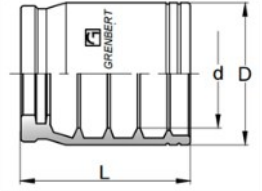

Part Number	Hose Size		d mm	D mm	L mm
	Inch	mm			
N5400 FERRULE					
N5400-04	1/4	6.4	15.8	22	26
N5400-05	5/16	7.9	17.5	24	27
N5400-06	3/8	9.5	19.8	26	30
N5400-08	1/2	12.7	23.2	30	32.5
N5400-10	5/8	15.9	26.5	34	35
N5400-12	3/4	19	30.4	38	40
N5400-16	1	25.4	39	48	50
N5400-20	1.1/4	31.8	49.3	60	57
N5400-24	1.1/2	38.1	55.5	67	62
N5400-32	2	50.8	69	80	66

N8000 FERRULE (NON SKIVE 4 WIRE SPIRAL HOSE)

Features

Matching Insert : G-Series Insert for size -6 to -16 (3/8" to 1")

Non-Skive

Hose Type: 4SP, R12

For Hose OD below "d" value

Material : Carbon Steel, Stainless Steel

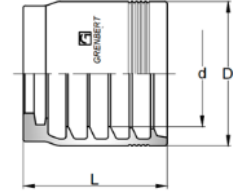

PART D
G/P Series

Part Number	Hose Size		d mm	D mm	L mm
	Inch	mm			
N8000 FERRULE					
N8000-06	3/8	9.5	21.2	29.5	30.7
N8000-08	1/2	12.7	24.5	33.4	32
N8000-10	5/8	15.9	28.0	37.2	36
N8000-12	3/4	19	31.5	41.3	40
N8000-16	1	25.4	38.8	49	51

S8000-SM FERRULE (EXTERNAL SKIVE 4 WIRE SPIRAL HOSE)

Features

Matching Insert : G-Series Insert -6 to -20 (3/8" to 1.1/4")

Non-Skive

Hose Type: 4SP, 4SH, R12

Material : Carbon Steel, Stainless Steel

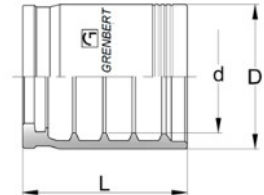

Part Number	Hose Size		d mm	D mm	L mm
	Inch	mm			
S8000-SM FERRULE					
S8000-06SM	3/8	9.5	18.5	26	32
S8000-08SM	1/2	12.7	21.5	30	34
S8000-10SM	5/8	15.9	25.5	34	37
S8000-12SM	3/4	19	29.5	38	42
S8000-16SM	1	25.4	36.5	46	52

S8900 FERRULE (EXTERNAL SKIVE 4-WIRE SPIRAL HOSE)

Features

Matching Insert: P Series for size -12 (3/4") to -32 (2")

External Skive

Hose Type: 4SP, 4SH, R12, STRATA BC, CC and DC

Material : Carbon Steel, Stainless Steel

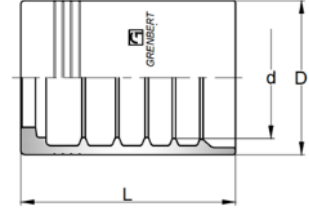

PART D
G/P Series

Part Number	Hose Size		d mm	D mm	L mm
	Inch	mm			
S8900 FERRULE					
S8900-12	3/4	19	29.5	38	51
S8900-16	1	25.4	36.5	46	63
S8900-20	1.1/4	31.8	43	53.5	74
S8900-24	1.1/2	38.1	50	61	78
S8900-32	2	50.8	64.5	77	95

S9000 FERRULE (EXTERNAL SKIVE SPIRAL HOSE)

Features

Matching Insert : P Series Insert

External Skive

Hose Type: R13, R15, STRATA CC and DC

Material : Carbon Steel, Stainless Steel

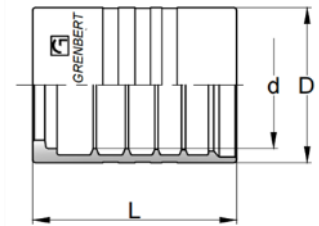

Part Number	Hose Size		d mm	D mm	L mm
	Inch	mm			
S9000 FERRULE					
S9000-16	1	25.4	38	48	65
S9000-20	1.1/4	31.8	49	60	76
S9000-24	1.1/2	38.1	56.7	69	80
S9000-32	2	50.8	70	83.7	97

S9000L FERRULE (EXTREME HIGH PRESSURE HIGH IMPULSE HOSE)

Features

Matching Insert : HT-Series Insert

External Skive

Hose Type: 4SH, R13,R15 STRATA 5000, 6000

Material : Carbon Steel

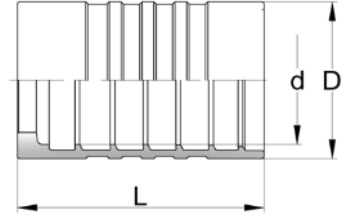

PART D
G/P Series

Part Number	Hose Size		d mm	D mm	L mm
	Inch	mm			
S9000L FERRULE					
S9000-20L	1.1/4	31.8	49.0	61	89.5
S9000-24L	1.1/2	38.1	56.5	69	105
S9000-32L	2	50.8	70.0	84.5	120

FTH FERRULE (THERMOPLASTIC HOSE)

Features

Matching Insert : For thermoplastic insert

Non-Skive

Hose Type: R7 and R8

For Hose OD below "d" value

Material : Carbon Steel, Stainless Steel

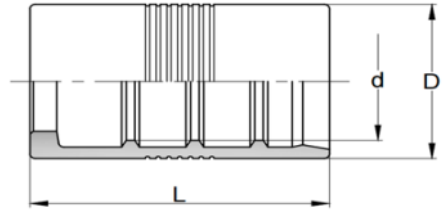

Part Number	Hose Size		d mm	D mm	L mm
	Inch	mm			
FTH7 FERRULE (For SAE100R7 hose)					
FTH7-03	3/16	5	10.8	14.2	25
FTH7-04	1/4	6.4	13	17	28
FTH7-05	5/16	7.9	15	19	28
FTH7-06	3/8	9.5	17	22	32
FTH7-08	1/2	12.7	21	25.5	34
FTH7-10	5/8	15.9	25	30	37
TFH7-12	3/4	19	28	33	42
FTH7-16	1	25.4	36	42	53
FTH8 FERRULE (For SAE100R8 hose)					
FTH8-04	1/4	6.4	16.3	21	29
FTH8-06	3/8	9.5	19.8	25	32
FTH8-08	1/2	12.7	23.5	28	34

MP MALE NPT

Features

Matching Ferrule: N5300, N5400, N8000, S8000SM, S8900, S9000

Material : Carbon Steel, Stainless Steel

Specification: SAE J516

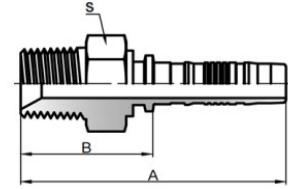

PART D
G/P Series

Part Number	Hose Size		Thread Inch	A mm	B mm	S mm
	Inch	mm				
G-SERIES						
G04-02MP	1/4	6.4	1/8-27	51	22	14
G04-04MP	1/4	6.4	1/4-18	55	27	17
G04-06MP	1/4	6.4	3/8-18	58.5	28.5	19
G06-04MP	3/8	9.5	1/4-18	56.5	26	17
G06-06MP	3/8	9.5	3/8-18	59	28.5	19
G06-08MP	3/8	9.5	1/2-14	64.5	34	22
G08-06MP	1/2	12.7	3/8-18	63.5	30.5	22
G08-08MP	1/2	12.7	1/2-14	68	35	22
G12-08MP	3/4	19	1/2-14	78	38	27
G12-12MP	3/4	19	3/4-14	78	38	27
G12-16MP	3/4	19	1-11.5	86	45	35
G16-16MP	1	25.4	1-11.5	98	47	35
G20-20MP	1.1/4	31.8	1.1/4-11.5	110	52	46
G24-24MP	1.1/2	38.1	1.1/2-11.5	120	55	50
G32-32MP	2	50.8	2-11.5	134	64	65
P-SERIES						
P12-12MP	3/4	19	3/4-14	92	40	30
P16-16MP	1	25.4	1-11.5	108	44	36
P20-20MP	1.1/4	31.8	1.1/4-11.5	128	54	46
P24-24MP	1.1/2	38.1	1.1/2-11.5	135	58	50
P32-32MP	2	50.8	2-11.5	160	72	65

MPX MALE NPT SWIVEL

Features

Matching Ferrule: N5300, N5400, N8000, S8000SM,

Material : Carbon Steel, Stainless Steel

Specification: SAE J516

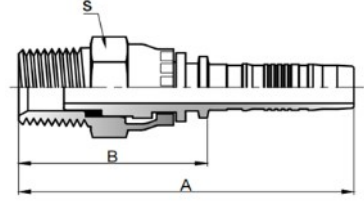

Part Number	Hose Size		Thread	A	B	S
	Inch	mm				
G-SERIES						
G04-02MPX	1/4	6.4	1/8-27	60	32	12.7
G04-04MPX	1/4	6.4	1/4-18	69	41	17
G04-06MPX	1/4	6.4	3/8-18	68	40	19
G06-06MPX	3/8	9.5	3/8-18	70	40	19
G06-08MPX	3/8	9.5	1/2-14	77	46	22
G08-08MPX	1/2	12.7	1/2-14	80	47	22
G12-12MPX	3/4	19	3/4-14	100	60	32
G16-16MPX	1	25.4	1-11.5	116	65	38

FP FEMALE NPSM SWIVEL (60° CONE)

Features

Matching Ferrule: N5300, N5400, N8000, S8000SM,

Material : Carbon Steel, Stainless Steel

Specification: SAE J516

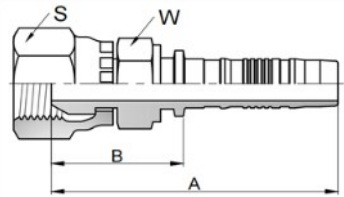

Part Number	Hose Size		Thread	A	B	W	S
	Inch	mm					
G-SERIES							
G04-04FP	1/4	6.4	1/4-18	52	24	17	19
G06-06FP	3/8	9.5	3/8-18	56	26	19	22
G08-08FP	1/2	12.7	1/2-14	63	30	22	27
G12-12FP	3/4	19	3/4-14	76	36	27	32
G16-16FP	1	25.4	1-11.5	90	40	35	38
G20-20FP	1.1/4	31.8	1.1/4-11.5	98	46	41	50
G24-24FP	1.1/2	38.1	1.1/2-11.5	108	44	46	55
G32-32FP	2	50.8	2-11.5	120	50	60	70

MJ MALE JIC 37° FLARE

Features

Matching Ferrule: N5300, N5400, N8000, S8000SM, S8900, S9000

Material : Carbon Steel, Stainless Steel

Specification: SAE J516 / ISO 12151-5

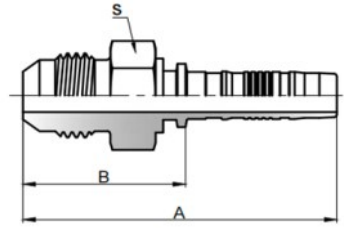

Part Number	Hose Size		Thread	A	B	S
	Inch	mm				
G-SERIES						
G04-04MJ	1/4	6.4	7/16x20	54	26	14
G04-05MJ	1/4	6.4	1/2x20	54	26	14
G04-06MJ	1/4	6.4	9/16x18	55	27	17
G05-06MJ	5/16	7.9	9/16x18	55	27	17
G06-06MJ	3/8	9.5	9/16x18	57.5	27	17
G06-08MJ	3/8	9.5	3/4x16	62	30	19
G06-10MJ	3/8	9.5	7/8x14	64.5	34	22
G08-08MJ	1/2	12.7	3/4x16	64	31	19
G08-10MJ	1/2	12.7	7/8x14	67.5	35	22
G10-10MJ	5/8	15.9	7/8x14	74	38	22
G08-12MJ	1/2	12.7	1.1/16x12	72	40	27
G10-12MJ	5/8	15.9	1.1/16x12	78	40	27
G12-12MJ	3/4	19	1.1/16x12	81	40	27
G12-16MJ	3/4	19	1.5/16x12	85	45	35
G16-16MJ	1	25.4	1.5/16x12	95	45	35
G20-20MJ	1.1/4	31.8	1.5/8x12	105	48	46
P-SERIES						
P12-12MJ	3/4	19	1.1/16x12	96	43	30
P16-16MJ	1	25.4	1.5/16x12	110	46	36
P20-20MJ	1.1/4	31.8	1.5/8x12	128	54	46
P24-24MJ	1.1/2	38.1	1.7/8x12	135	58	50
P32-32MJ	2	50.8	2.1/2x12	160	72	65

FJ FEMALE JIC 37° FLARE SWIVEL

Features

Matching Ferrule: N5300, N5400, N8000, S8000SM, S8900, S9000

Material : Carbon Steel, Stainless Steel

Specification: SAE J516 / ISO 12151-5

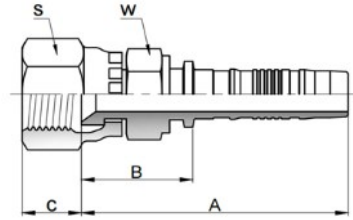

Part Number	Hose Size		Thread	A	B	C	W	S
	Inch	mm						

G-SERIES

G04-04FJ	1/4	6.4	7/16x20	43.5	20	8.7	14	14.3
G04-04FJ-S16	1/4	6.4	7/16x20	43.5	20	8.7	14	16
G04-05FJ	1/4	6.4	1/2x20	44	20.5	9.5	14	17
G04-06FJ	1/4	6.4	9/16x18	45	21.5	9.5	14	19
G05-05FJ	5/16	7.9	1/2x20	44.5	21	9.5	14	17
G05-06FJ	5/16	7.9	9/16x18	45	21.5	9.5	17	19
G06-06FJ	3/8	9.5	9/16x18	49	22.5	9.5	17	19
G06-08FJ	3/8	9.5	3/4x16	51	24.5	10.7	19	22
G06-10FJ	3/8	9.5	7/8x14	53	26.5	12.7	22	27
G08-08FJ	1/2	12.7	3/4x16	53.5	25.5	10.7	19	22
G08-10FJ	1/2	12.7	7/8x14	55.5	27.5	10.7	22	27
G10-10FJ	5/8	15.9	7/8x14	59	28	12.7	22	27
G10-12FJ	5/8	15.9	1.1/16x12	61.5	30.5	14.3	27	32
G12-12FJ	3/4	19.1	1.1/16x12	68	32	14.3	27	32
G12-16FJ	3/4	19.1	1.5/16x12	71.5	35.5	15.1	32	38
G16-16FJ	1	25.4	1.5/16x12	79	36	15.1	32	38
G16-20FJ	1	25.4	1.5/8x12	85	42	15.9	41	50
G20-20FJ	1.1/4	31.8	1.5/8x12	93	43	15.9	41	50
G24-24FJ	1.1/2	38.1	1.7/8x12	100.5	45.5	18.6	46	55
G32-32FJ	2	50.8	2.1/2x12	111	52.5	23.8	60	70

P-SERIES

P12-12FJ	3/4	19.1	1.1/16x12	86.5	35	14.3	30	32
P16-16FJ	1	25.4	1.5/16x12	97.5	38	15.1	36	41
P20-20FJ	1.1/4	31.8	1.5/8x12	118	45	15.9	46	50
P24-24FJ	1.1/2	38.1	1.7/8x12	125	50	18.6	50	60
P32-32FJ	2	50.8	2.1/2x12	150	62	23.8	65	75

FJC FEMALE JIC 37° FLARE SWIVEL (SINGLE HEX)

Features

Matching Ferrule: N5300, N5400, N8000, S8000SM, S8900, S9000

Material : Carbon Steel, Stainless Steel

Specification: SAE J516 / ISO 12151-5

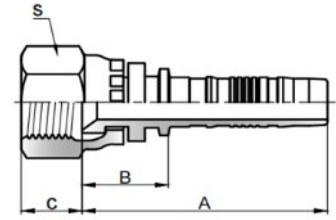

Part Number	Hose Size		Thread	A	B	C	S
	Inch	mm					
G-SERIES							
G03-04FJC	3/16	5.0	7/16x20	44	15	8.7	14.3
G04-04FJC	1/4	6.4	7/16x20	44	16	8.7	14.3
G04-04FJC-S16	1/4	6.4	7/16x20	44	16	8.7	16
G04-05FJC	1/4	6.4	1/2x20	44	16	9.5	17
G04-06FJC	1/4	6.4	9/16x18	46	18	9.5	19
G05-05FJC	5/16	7.9	1/2x20	44	17	9.5	17
G05-06FJC	5/16	7.9	9/16x18	45	17	9.5	19
G06-06FJC	3/8	9.5	9/16x18	48	18	9.5	19
G06-08FJC	3/8	9.5	3/4x16	49	19	10.7	22
G06-10FJC	3/8	9.5	7/8x14	50	20	12.7	27
G08-08FJC	1/2	12.7	3/4x16	53	20	10.7	22
G08-10FJC	1/2	12.7	7/8x14	53	20	10.7	27
G10-10FJC	5/8	15.9	7/8x14	55.5	20.5	12.7	27
G10-12FJC	5/8	15.9	1.1/16x12	60	24	14.3	32
G12-12FJC	3/4	19.1	1.1/16x12	63	23	14.3	32
G12-16FJC	3/4	19.1	1.5/16x12	66	25	15.1	38
G16-16FJC	1	25.4	1.5/16x12	76	25	15.1	38
G16-20FJC	1	25.4	1.5/8x12	80	30	15.9	50
G20-20FJC	1.1/4	31.8	1.5/8x12	88	31	15.9	50
G24-24FJC	1.1/2	38.1	1.7/8x12	94	30	18.6	55
G32-32FJC	2	50.8	2.1/2x12	106	36	23.8	70
P-SERIES							
P12-12FJC	3/4	19.1	1.1/16x12	78	26	14.3	32
P16-16FJC	1	25.4	1.5/16x12	90	28	15.1	41
P20-20FJC	1.1/4	31.8	1.5/8x12	106	32	15.9	50
P24-24FJC	1.1/2	38.1	1.7/8x12	112	36	18.6	60
P32-32FJC	2	50.8	2.1/2x12	134	46	23.8	75

FJ45 FEMALE JIC 37° FLARE SWIVEL 45° ELBOW

Features

Matching Ferrule: 5300N5300, N5400, N8000, S8000SM, S8900, S9000

Material : Carbon Steel, Stainless Steel

Specification: SAE J516 / ISO 12151-5

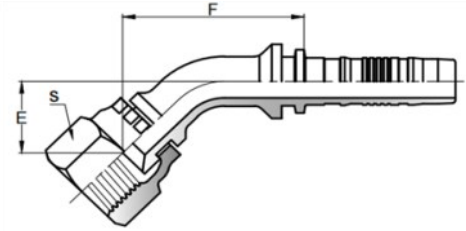

Part Number	Hose Size		Thread	E	F	S
	Inch	mm				

G-SERIES

G04-04FJ45	1/4	6.4	7/16x20	13	35	14.3
G04-04FJ45-S16	1/4	6.4	7/16x20	13	35	16
G04-05FJ45	1/4	6.4	1/2x20	13	35	17
G04-06FJ45	1/4	6.4	9/16x18	14	35	19
G05-05FJ45	5/16	7.9	1/2x20	14	37	17
G05-06FJ45	5/16	7.9	9/16x18	15	38	19
G06-06FJ45	3/8	9.5	9/16x18	15	42	19
G06-08FJ45	3/8	9.5	3/4x16	19	46	22
G06-10FJ45	3/8	9.5	7/8x14	20	50	27
G08-08FJ45	1/2	12.7	3/4x16	18	52	22
G08-10FJ45	1/2	12.7	7/8x14	19	52	27
G10-10FJ45	5/8	15.9	7/8x14	21	60	27
G10-12FJ45	5/8	15.9	1.1/16x12	23	60	32
G12-12FJ45	3/4	19.1	1.1/16x12	25	70	32
G12-16FJ45	3/4	19.1	1.5/16x12	27	70	38
G16-16FJ45	1	25.4	1.5/16x12	30	85	38
G16-20FJ45	1	25.4	1.5/8x12	33	90	50
G20-20FJ45	1.1/4	31.8	1.5/8x12	40	105	50
G24-24FJ45	1.1/2	38.1	1.7/8x12	45	120	55
G32-32FJ45	2	50.8	2.1/2x12	57	155	70

P-SERIES

P12-12FJ45	3/4	19	1.1/16x12	25	70	32
P16-16FJ45	1	25.4	1.5/16x12	30	86	41
P20-20FJ45	1.1/4	31.8	1.5/8x12	40	105	50
P24-24FJ45	1.1/2	38.1	1.7/8x12	45	140	60
P32-32FJ45	2	50.8	2.1/2x12	57	158	75

FJ90 FEMALE JIC 37° FLARE SWIVEL 90° ELBOW

Features

Matching Ferrule: N5300, N5400, N8000, S8000SM, S8900, S9000

Material : Carbon Steel, Stainless Steel

Specification: SAE J516 / ISO 12151-5

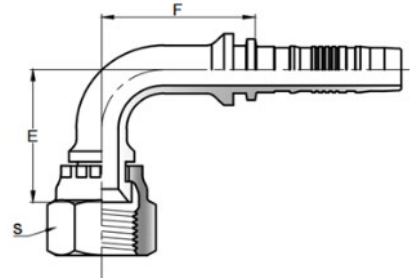

Part Number	Hose Size		Thread	E	F	S
	Inch	mm				

G-SERIES

G04-04FJ90	1/4	6.4	7/16x20	24	27	14.3
G04-04FJ90-S16	1/4	6.4	7/16x20	24	27	16
G04-05FJ90	1/4	6.4	1/2x20	25	27	17
G04-06FJ90	1/4	6.4	9/16x18	26	27	19
G05-05FJ90	5/16	7.9	1/2x20	28	31	17
G05-06FJ90	5/16	7.9	9/16x18	28.5	31	19
G06-06FJ90	3/8	9.5	9/16x18	29	33	19
G06-08FJ90	3/8	9.5	3/4x16	34	35	22
G06-10FJ90	3/8	9.5	7/8x14	35	40	27
G08-08FJ90	1/2	12.7	3/4x16	35	42	22
G08-10FJ90	1/2	12.7	7/8x14	36	42	27
G10-10FJ90	5/8	15.9	7/8x14	42	48	27
G10-12FJ90	5/8	15.9	1.1/16x12	45	48	32
G12-12FJ90	3/4	19	1.1/16x12	52	58	32
G12-16FJ90	3/4	19	1.5/16x12	54	58	38
G16-16FJ90	1	25.4	1.5/16x12	63	74	38
G16-20FJ90	1	25.4	1.5/8x12	70	75	50
G20-20FJ90	1.1/4	31.8	1.5/8x12	81	93	50
G24-24FJ90	1.1/2	38.1	1.7/8x12	92	103	55
G32-32FJ90	2	50.8	2.1/2x12	120	125	70

P-SERIES

P12-12FJ90	3/4	19	1.1/16x12	52	66	32
P16-16FJ90	1	25.4	1.5/16x12	70	78	41
P20-20FJ90	1.1/4	31.8	1.5/8x12	82	102	50
P24-24FJ90	1.1/2	38.1	1.7/8x12	95	120	60
P32-32FJ90	2	50.8	2.1/2x12	140	150	75

FJ90L FEMALE JIC 37° FLARE SWIVEL / 90° ELBOW (LONG DROP)

Features

Matching Ferrule: N5300, N5400, N8000, S8000SM, S8900, S9000

Material : Carbon Steel, Stainless Steel

Specification: SAE J516 / ISO 12151-5

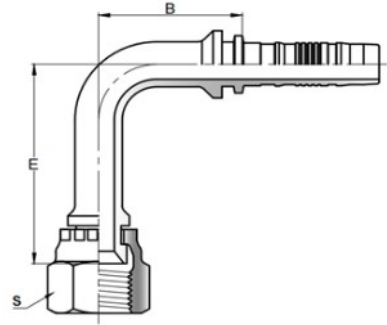

Part Number	Hose Size		Thread	E	B	S
	Inch	mm				

G-SERIES

G04-04FJ90-46	1/4	6.4	7/16x20	46	27	14.3
G04-06FJ90-54	1/4	6.4	9/16x18	54	27	19
G06-06FJ90-54	3/8	9.5	9/16x18	54	33	19
G06-08FJ90-64	3/8	9.5	3/4x16	64	35	22
G08-08FJ90-64	1/2	12.7	3/4x16	64	42	22
G08-10FJ90-70	1/2	12.7	7/8x14	70	42	27
G10-10FJ90-70	5/8	15.9	7/8x14	70	48	27
G12-12FJ90-96	3/4	19	1.1/16x12	96	58	32
G16-16FJ90-114	1	25.4	1.5/16x12	114	74	38

P-SERIES

P12-12FJ90-96	3/4	19	1.1/16x12	96	66	32
P16-16FJ90-114	1	25.4	1.5/16x12	114	78	41

PART D
G/P Series

FJ90S FEMALE JIC 37° SWIVEL / 90° ELBOW (SHORT DROP)

Features

Matching Ferrule: N5300, N5400, N8000, S8000SM,

Material : Carbon Steel, Stainless Steel

Specification: SAE J516 / ISO 12151-5

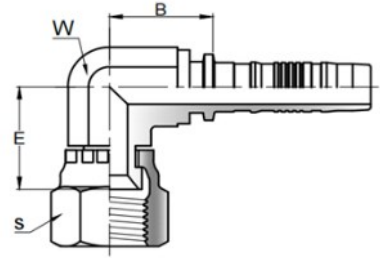

PART D
G/P Series

Part Number	Hose Size		Thread	B	E	W	S
	Inch	mm					
G-SERIES							
G04-04FJ90-S	1/4	6.4	7/16x20	17	17	11	14.3
G04-06FJ90-S	1/4	6.4	9/16x18	21	22	14	19
G06-06FJ90-S	3/8	9.5	9/16x18	21	22	14	19
G06-08FJ90-S	3/8	9.5	3/4x16	25.8	23	19	22
G08-08FJ90-S	1/2	12.7	3/4x16	25.8	23	19	22
G08-10FJ90-S	1/2	12.7	7/8x14	25.8	24	19	27
G10-10FJ90-S	5/8	15.9	7/8x14	27	28	22	27
G12-12FJ90-S	3/4	19	1.1/16x12	33.2	30	27	32
G16-16FJ90-S	1	25.4	1.5/16x12	38	38	33	38

MOB MALE SAE O-RING BOSS

Features

Matching Ferrule: N5300, N5400, N8000, S8000SM,

Material: Carbon Steel, Stainless Steel

Specification: SAE J516 / ISO J1926-2

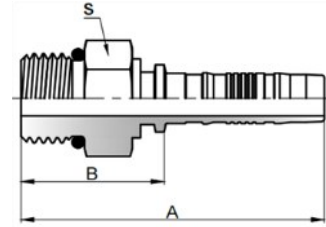

Part Number	Hose Size		Thread	A	B	S
	Inch	mm				
G-SERIES						
04-04MOB	1/4	6.4	7/16x20	50	22	14
04-06MOB	1/4	6.4	9/16x18	51.5	23.5	17
06-06MOB	3/8	9.5	9/16x18	54	24	17
06-08MOB	3/8	9.5	3/4x16	57	27	22
08-08MOB	1/2	12.7	3/4x16	60	27	22
08-10MOB	1/2	12.7	7/8x14	63	30	27
10-10MOB	5/8	15.9	7/8x14	66	30	27
12-12MOB	3/4	19	1.1/16x12	75	35	32
16-16MOB	1	25.4	1.5/16x12	89	38	38

MOBX MALE SAE O-RING BOSS SWIVEL

Features

Matching Ferrule: N5300, N5400, N8000, S8000SM

Material: Carbon Steel, Stainless Steel

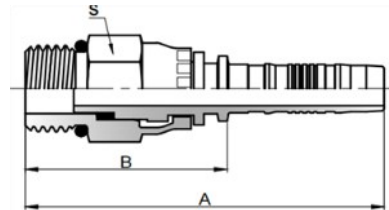

Part Number	Hose Size		Thread	A	B	S
	Inch	mm				
G-SERIES						
04-04MOBX	1/4	6.4	7/16x20	70	42	17
04-06MOBX	1/4	6.4	9/16x18	70	42	19
06-06MOBX	3/8	9.5	9/16x18	73	42	19
06-08MOBX	3/8	9.5	3/4x16	75	44	22
08-08MOBX	1/2	12.7	3/4x16	80	47	22
08-10MOBX	1/2	12.7	7/8x14	83	50	27
10-10MOBX	5/8	15.9	7/8x14	86	50	27
12-12MOBX	3/4	19	1.1/16x12	96	56	32

FS FEMALE SAE 45° FLARE SWIVEL

Features

Matching Ferrule: N5300, N5400, N8000, S8000SM-

Material : Carbon Steel, Stainless Steel

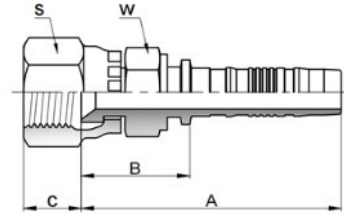

Part Number	Hose Size		Thread	A	B	W	S
	Inch	mm					
G-SERIES							
G04-06FS	1/4	6.4	5/8-18	51	23	17	22
G06-06FS	3/8	9.5	5/8-18	54	24	19	22
G12-12FS	3/4	19	1.1/16-14	70	30	27	32

FS90 FEMALE SAE 45° FLARE SWIVEL 90° ELBOW

Features

Matching Ferrule: 5300N5300, N5400, N8000

Material : Carbon Steel, Stainless Steel

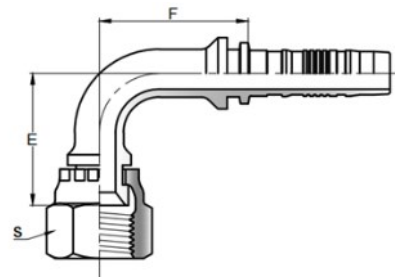

Part Number	Hose Size		Thread	E	F	S
	Inch	mm				
G-SERIES						
G04-06FS90	1/4	6.4	5/8-18	29	26	22
G06-06FS90	3/8	9.5	5/8-18	31	31	22
G12-12FS90	3/4	19	1.1/16-14	52	58	32

PART D
G/P Series

MF MALE O-RING FACE SEAL (ORFS)

Features

Matching Ferrule: N5300, N5400, N8000, S8000SM, S8900, S9000

Material : Carbon Steel, Stainless Steel

Specification: SAE J516 / ISO 12151-1

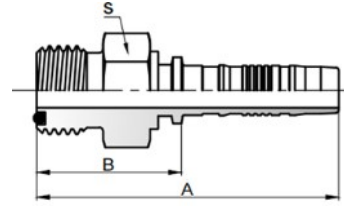

Part Number	Hose Size		Thread	A	B	S
	Inch	mm				
G-SERIES						
G04-04MF	1/4	6.4	9/16×18	52	24	17
G04-06MF	1/4	6.4	11/16×16	53	25	19
G06-06MF	3/8	9.5	11/16×16	56.5	26	19
G06-08MF	3/8	9.5	13/16×16	58.5	28	22
G08-08MF	1/2	12.7	13/16×16	62	29	22
G08-10MF	1/2	12.7	1×14	67.5	34.5	27
G10-10MF	5/8	15.9	1×14	71.5	33.5	27
G10-12MF	5/8	15.9	1.3/16×12	71	35	32
G12-12MF	3/4	19	1.3/16×12	77	36	32
G16-16MF	1	25.4	1.7/16×12	91	42	38
G20-20MF	1.1/4	31.8	1.11/16×12	100	43	46
G24-24MF	1.1/2	38.1	2×12	112	48	55
P-SERIES						
P12-12MF	3/4	19	1.3/16×12	90	37	32
P16-16MF	1	25.4	1.7/16×12	103	41	41

PART D
G/P Series

FF FEMALE O-RING FACE SEAL SWIVEL (ORFS - DOUBLE HEX NUT)

Features

Matching Ferrule: N5300, N5400, N8000, S8000SM, S8900, S9000

Material : Carbon Steel, Stainless Steel

Material : Carbon Steel, Stainless Steel

Specification: SAE J516 / ISO 12151-1

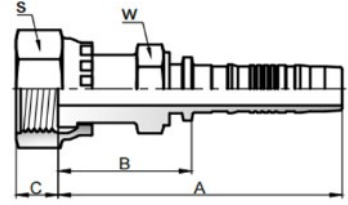

Part Number	Hose Size		Thread	A	B	C	W	S
	Inch	mm						
G-SERIES								
G04-04FFC	1/4	6.4	9/16×18	54.5	26.5	8	14	17
G04-06FFC	1/4	6.4	11/16×16	55	27	9.5	17	22
G06-06FFC	3/8	9.5	11/16×16	62	32	9.5	19	22
G06-08FFC	3/8	9.5	13/16×16	64	34	11.5	19	24
G08-08FFC	1/2	12.7	13/16×16	67	34	11.5	22	24
G08-10FFC	1/2	12.7	1×14	73	40	13.5	24	30
G10-10FFC	5/8	15.9	1×14	76	40	13.5	24	30
G10-12FFC	5/8	15.9	1.3/16×12	78.5	43	14.5	27	36
G12-12FFC	3/4	19	1.3/16×12	84	44	14.5	27	36
G16-16FFC	1	25.4	1.7/16×12	100	50	14.5	35	41
G20-20FFC	1.1/4	31.8	1.11/16×12	109	52	14.5	41	50
G24-24FFC	1.1/2	38.1	2×12	119	55	14.5	50	60
P-SERIES								
P12-12FF	3/4	19	1.3/16×12	100	47	14.5	30	36
P16-16FF	1	25.4	1.7/16×12	110	50	14.5	36	41
P20-20FF	1.1/4	31.8	1.11/16×12	130	56	14.5	46	50
P24-24FF	1.1/2	38.1	2×12	137	61	14.5	50	60

PART D
G/P Series

FFC FEMALE O-RING FACE SEAL SWIVEL (ORFS – SINGLE HEX)

Features

Matching Ferrule: N5300, N5400, N8000, S8000SM, S8900, S9000

Material : Carbon Steel, Stainless Steel

Material : Carbon Steel, Stainless Steel

Specification: SAE J516 / ISO 12151-1

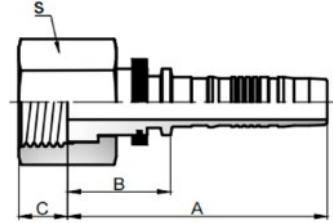

Part Number	Hose Size		Thread	A	B	C	S
	Inch	mm					
G-SERIES							
G04-04FFC	1/4	6.4	9/16×18	47	19	8	17
G04-06FFC	1/4	6.4	11/16×16	53.5	25	9.5	22
G06-06FFC	3/8	9.5	11/16×16	56	26	9.5	22
G06-08FFC	3/8	9.5	13/16×16	53	23	11.5	24
G08-08FFC	1/2	12.7	13/16×16	60	27	11.5	24
G08-10FFC	1/2	12.7	1×14	60	27	13.5	30
G10-10FFC	5/8	15.9	1×14	63	28	13.5	30
G10-12FFC	5/8	15.9	1.3/16×12	67	32	14.5	36
G12-12FFC	3/4	19	1.3/16×12	73	33	14.5	36
G16-16FFC	1	25.4	1.7/16×12	90	40	14.5	41
G20-20FFC	1.1/4	31.8	1.11/16×12	96	40	14.5	50
G24-24FFC	1.1/2	38.1	2×12	104	40	14.5	60
P-SERIES							
P12-12FFC	3/4	19	1.3/16×12	81	29	14.5	36
P16-16FFC	1	25.4	1.7/16×12	93	31	14.5	41

PART D
G/P Series

FF45 FEMALE O-RING FACE SEAL SWIVEL 45° ELBOW (ORFS)

Features

Matching Ferrule: N5300, N5400, N8000, S8000SM, S8900, S9000

Material : Carbon Steel, Stainless Steel

Material : Carbon Steel, Stainless Steel

Specification: SAE J516 / ISO 12151-1

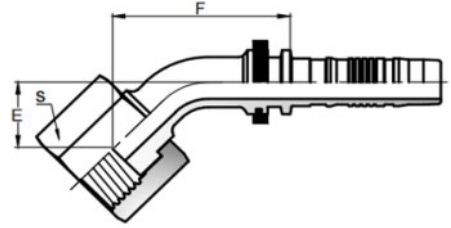

Part Number	Hose Size		Thread Inch	E mm	F mm	S mm
	Inch	mm				
G-SERIES						
G04-04FF45	1/4	6.4	9/16×18	11	37	17
G04-06FF45	1/4	6.4	11/16×16	12	38	22
G06-06FF45	3/8	9.5	11/16×16	12	40	22
G06-08FF45	3/8	9.5	13/16×16	15	40	24
G08-08FF45	1/2	12.7	13/16×16	14.5	48	24
G08-10FF45	1/2	12.7	1×14	17.5	50	30
G10-10FF45	5/8	15.9	1×14	17.5	58	30
G10-12FF45	5/8	15.9	1.3/16×12	21	58	36
G12-12FF45	3/4	19	1.3/16×12	22	72	36
G16-16FF45	1	25.4	1.7/16×12	25.5	84	41
G20-20FF45	1.1/4	31.8	1.11/16×12	32.5	103	50
G24-24FF45	1.1/2	38.1	2×12	39	120	60
P-SERIES						
P12-12FF45	3/4	19	1.3/16×12	22	74	36
P16-16FF45	1	25.4	1.7/16×12	25.5	84	41
P20-20FF45	1.1/4	31.8	1.11/16×12	32	112	50
P24-24FF45	1.1/2	38.1	2×12	42	136	60

PART D
G/P Series

FF90 FEMALE O-RING FLAT FACE SWIVEL 90° ELBOW (ORFS)

Features

Matching Ferrule: 5300N5300, N5400, N8000, S8000SM, S8900, S9000

Material : Carbon Steel, Stainless Steel

Material : Carbon Steel, Stainless Steel

Specification: SAE J516 / ISO 12151-1

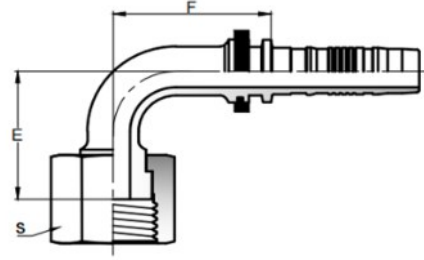

Part Number	Hose Size		Thread	E	F	S
	Inch	mm				
G-SERIES						
G04-04FF90	1/4	6.4	9/16×18	21	32	17
G04-06FF90	1/4	6.4	11/16×16	23	32	22
G06-06FF90	3/8	9.5	11/16×16	24.5	36	22
G06-08FF90	3/8	9.5	13/16×16	29	46	24
G08-08FF90	1/2	12.7	13/16×16	29	45	24
G08-10FF90	1/2	12.7	1×14	34	45	30
G10-10FF90	5/8	15.9	1×14	36	48	30
G10-12FF90	5/8	15.9	1.3/16×12	42	48	36
G12-12FF90	3/4	19	1.3/16×12	48	64	36
G16-16FF90	1	25.4	1.7/16×12	57	76	41
G20-20FF90	1.1/4	31.8	1.11/16×12	73	98	50
G24-24FF90	1.1/2	38.1	2×12	86	112	60
P-SERIES						
P12-12FF90	3/4	19	1.3/16×12	48	70	36
P16-16FF90	1	25.4	1.7/16×12	57	80	41
P20-20FF90	1.1/4	31.8	1.11/16×12	78	97	50
P24-24FF90	1.1/2	38.1	2×12	86	118	60

FF90L FEMALE O-RING FACE SEAL SWIVEL 90° ELBOW - LONG DROP (ORFS)
Features

Matching Ferrule: 5300N5300, N5400, N8000, S8000SM, S8900, S9000

Material : Carbon Steel, Stainless Steel

Material : Carbon Steel, Stainless Steel

Specification: SAE J516 / ISO 12151-1

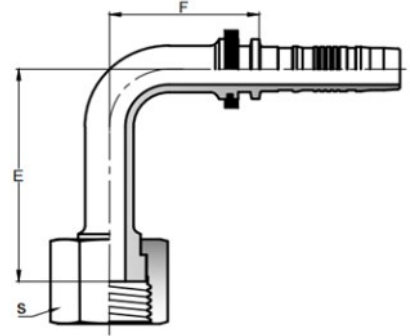
 PART D
G/P Series

Part Number	Hose Size		Thread	E	F	S
	Inch	mm				

G-SERIES

G04-04FF90-46	1/4	6.4	9/16×18	46	32	17
G04-06FF90-54	1/4	6.4	11/16×16	54	32	22
G06-06FF90-54	3/8	9.5	11/16×16	54	36	22
G06-08FF90-64	3/8	9.5	13/16×16	64	46	24
G08-08FF90-64	1/2	12.7	13/16×16	64	45	24
G08-10FF90-70	1/2	12.7	1×14	70	45	30
G10-10FF90-70	5/8	15.9	1×14	70	48	30
G10-12FF90-96	5/8	15.9	1.3/16×12	96	48	36
G12-12FF90-96	3/4	19	1.3/16×12	96	64	36
G16-16FF90-114	1	25.4	1.7/16×12	114	76	41
G20-20FF90-129	1.1/4	31.8	1.11/16×12	129	98	50

P-SERIES

P12-12FF90-96	3/4	19	1.3/16×12	96	70	36
P16-16FF90-114	1	25.4	1.7/16×12	114	80	41

FL SAE CODE 61 FLANGE

Features

Matching Ferrule: N5300, N5400, N8000, S8000SM, S8900, S9000

Material : Carbon Steel, Stainless Steel

Specification: SAE J516 / ISO 12151-3

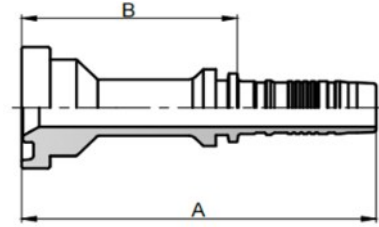

Part Number	Hose Size		Flange		A mm	B mm
	Inch	mm	Inch	mm		
G-SERIES						
G08-08FL	1/2	12.7	1/2	30.2	75	42
G08-12FL	1/2	12.7	3/4	38.1	78	45
G10-10FL	5/8	15.9	5/8	34.0	80	44
G10-12FL	5/8	15.9	3/4	38.1	80	44
G12-12FL	3/4	19	3/4	38.1	90	49
G12-16FL	3/4	19	1	44.5	95	54
G16-16FL	1	25.4	1	44.5	110	59
G16-20FL	1	25.4	1.1/4	50.8	110	59
G20-20FL	1.1/4	31.8	1.1/4	50.8	125	68
G20-24FL	1.1/4	31.8	1.1/2	60.3	125	68
G24-24FL	1.1/2	38.1	1.1/2	60.3	140	76
G24-32FL	1.1/2	38.1	2	71.4	140	76
G32-32FL	2	50.8	2	71.4	145	75
G32-40FL	2	50.8	2.1/2	84.1	150	80
P-SERIES						
P12-12FL	3/4	19	3/4	38.1	110	58
P12-16FL	3/4	19	1	44.5	112	60
P16-16FL	1	25.4	1	44.5	125	63
P16-20FL	1	25.4	1.1/4	50.8	125	63
P20-20FL	1.1/4	31.8	1.1/4	50.8	150	76
P20-24FL	1.1/4	31.8	1.1/2	60.3	150	76
P24-24FL	1.1/2	38.1	1.1/2	60.3	156	80
P24-32FL	1.1/2	38.1	2	71.4	160	84
P32-32FL	2	50.8	2	71.4	177	89

FL22.5 SAE CODE 61 FLANGE 22.5° ELBOW

Features

Matching Ferrule: N5300, N5400, N8000, S8000SM, S8900, S9000

Material : Carbon Steel, Stainless Steel

Specification: SAE J516 / ISO 12151-3

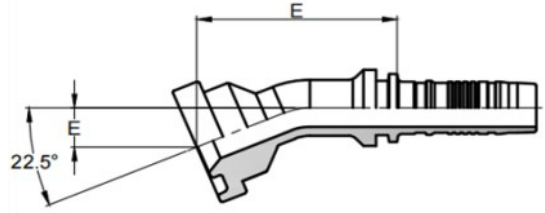

Part Number	Hose Size		Flange		E mm	F mm
	Inch	mm	Inch	mm		
G-SERIES						
G12-12FL22.5	3/4	19	3/4	38.1	11	72
G12-16FL22.5	3/4	19	1	44.5	14	76
G16-16FL22.5	1	25.4	1	44.5	14	86
G16-20FL22.5	1	25.4	1.1/4	50.8	15	91
G20-20FL22.5	1.1/4	31.8	1.1/4	50.8	15	110
G20-24FL22.5	1.1/4	31.8	1.1/2	60.3	18	114
G24-24FL22.5	1.1/2	38.1	1.1/2	60.3	18	135
G24-32FL22.5	1.1/2	38.1	2	71.4	20	142
G32-32FL22.5	2	50.8	2	71.4	22	160
P-SERIES						
P12-12FL22.5	3/4	19	3/4	38.1	11	75
P12-16FL22.5	3/4	19	1	44.5	14	80
P16-16FL22.5	1	25.4	1	44.5	14	90
P16-20FL22.5	1	25.4	1.1/4	50.8	15	93
P20-20FL22.5	1.1/4	31.8	1.1/4	50.8	15	115
P20-24FL22.5	1.1/4	31.8	1.1/2	60.3	18	118
P24-24FL22.5	1.1/2	38.1	1.1/2	60.3	18	140
P24-32FL22.5	1.1/2	38.1	2	71.4	20	147
P32-32FL22.5	2	50.8	2	71.4	22	168

 PART D
G/P Series

FL30 SAE CODE 61 FLANGE 30° ELBOW

Features

Matching Ferrule: N5300, N5400, N8000, S8000SM, S8900, S9000

Material : Carbon Steel, Stainless Steel

Specification: SAE J516 / ISO 12151-3

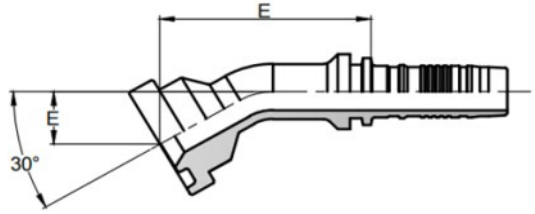

Part Number	Hose Size		Flange		E mm	F mm
	Inch	mm	Inch	mm		
G-SERIES						
G12-12FL30	3/4	19	3/4	38.1	18	70
G16-16FL30	1	25.4	1	44.5	19	90
G20-20FL30	1.1/4	31.8	1.1/4	50.8	22	112
G24-24FL30	1.1/2	38.1	1.1/2	60.3	25	132
G32-32FL30	2	50.8	2	71.4	32	156
P-SERIES						
P12-12FL30	3/4	19	3/4	38.1	18	78
P16-16FL30	1	25.4	1	44.5	19	95
P20-20FL30	1.1/4	31.8	1.1/4	50.8	11	112
P24-24FL30	1.1/2	38.1	1.1/2	60.3	25	137
P32-32FL30	2	50.8	2	71.4	32	164

PART D
G/P Series

FL45 SAE CODE 61 FLANGE 45° ELBOW

Features

Matching Ferrule: N5300, N5400, N8000, S8000SM, S8900, S9000

Material : Carbon Steel, Stainless Steel

Specification: SAE J516 / ISO 12151-3

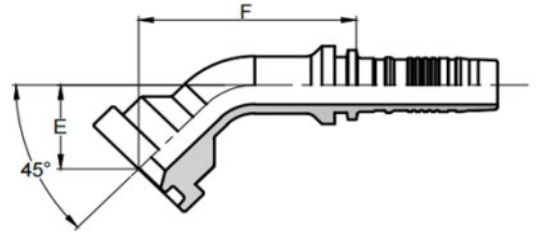

PART D
G/P Series

Part Number	Hose Size		Flange		E mm	F mm
	Inch	mm	Inch	mm		
G-SERIES						
G08-08FL45	1/2	12.7	1/2	30.2	20	55
G08-12FL45	1/2	12.7	3/4	38.1	22	60
G10-10FL45	5/8	15.9	5/8	34.0	22.5	60
G10-12FL45	5/8	15.9	3/4	38.1	23	60
G12-12FL45	3/4	19	3/4	38.1	24	70
G12-16FL45	3/4	19	1	44.5	26	70
G16-16FL45	1	25.4	1	44.5	30	85
G16-20FL45	1	25.4	1.1/4	50.8	30	88
G20-20FL45	1.1/4	31.8	1.1/4	50.8	34	110
G20-24FL45	1.1/4	31.8	1.1/2	60.3	36	114
G24-24FL45	1.1/2	38.1	1.1/2	60.3	40	130
G24-32FL45	1.1/2	38.1	2	71.4	46	136
G32-32FL45	2	50.8	2	71.4	56	170
P-SERIES						
P12-12FL45	3/4	19	3/4	38.1	24	74
P12-16FL45	3/4	19	1	44.5	26	74
P16-16FL45	1	25.4	1	44.5	30	90
P16-20FL45	1	31.8	1.1/4	50.8	30	90
P20-20FL45	1.1/4	31.8	1.1/4	50.8	34	114
P20-24FL45	1.1/4	38.1	1.1/2	60.3	36	118
P24-24FL45	1.1/2	38.1	1.1/2	60.3	40	130
P24-32FL45	1.1/2	50.8	2	71.4	46	140
P32-32FL45	2	50.8	2	71.4	56	175

FL45L SAE CODE 61 FLANGE 45° ELBOW—LONG DROP

Features

Matching Ferrule: N5300, N5400, N8000, 8000SM, S8900, S9000

Material : Carbon Steel, Stainless Steel

Specification: SAE J516 / ISO 12151-3

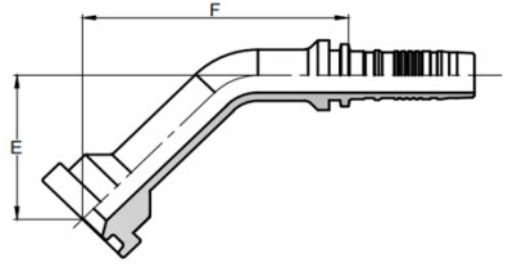

Part Number	Hose Size		Flange		E mm	F mm
	Inch	mm	Inch	mm		
G-SERIES						
G08-08FL45-L4	1/2	12.7	1/2	30.2	71	105
G08-08FL45-L6	1/2	12.7	1/2	30.2	106	140
P-SERIES						
P12-12FL90-L4	3/4	19	3/4	38.1	71	116
P12-12FL90-L5	3/4	19	3/4	38.1	88	134
P12-12FL90-L6	3/4	19	3/4	38.1	106	152
P12-16FL90-L4	3/4	19	1	44.5	71	116
P12-16FL90-L6	3/4	19	1	44.5	106	152
P16-16FL90-L4	1	25.4	1	44.5	71	132
P16-16FL90-L5	1	25.4	1	44.5	88	150
P16-16FL90-L6	1	25.4	1	44.5	106	168
P16-20FL90-L4	1	31.8	1.1/4	50.8	71	132
P16-20FL90-L6	1	31.8	1.1/4	50.8	106	168
P20-20FL90-L6	1.1/4	31.8	1.1/4	50.8	106	186

PART D
G/P Series

FL60 SAE CODE 61 FLANGE 60° ELBOW

Features

Matching Ferrule: N5300, N5400, N8000, S8000SM, S8900, S9000

Material : Carbon Steel, Stainless Steel

Specification: SAE J516 / ISO 12151-3

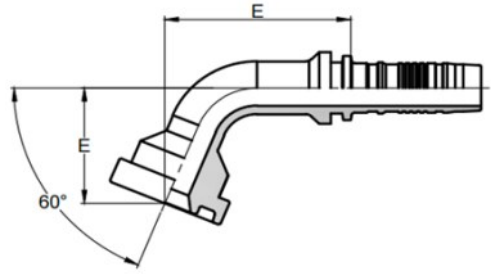

Part Number	Hose Size		Flange		E	F
	Inch	mm	Inch	mm		
G-SERIES						
G12-12FL60	3/4	19	3/4	38.1	37	74
G16-16FL60	1	25.4	1	44.5	44	86
G20-20FL60	1.1/4	31.8	1.1/4	50.8	48	110
G24-24FL60	1.1/2	38.1	1.1/2	60.3	55	135
G32-32FL60	2	50.8	2	71.4	80	166
P-SERIES						
P12-12FL60	3/4	19	3/4	38.1	37	74
P16-16FL60	1	25.4	1	44.5	44	90
P20-20FL60	1.1/4	31.8	1.1/4	50.8	48	112
P24-24FL60	1.1/2	38.1	1.1/2	60.3	55	138
P32-32FL60	2	50.8	2	71.4	80	175

PART D
G/P Series

FL67.5 SAE CODE 61 FLANGE 67.5° ELBOW

Features

Matching Ferrule: N5300, N5400, N8000, S8000SM, S8900, S9000

Material : Carbon Steel, Stainless Steel

Specification: SAE J516 / ISO 12151-3

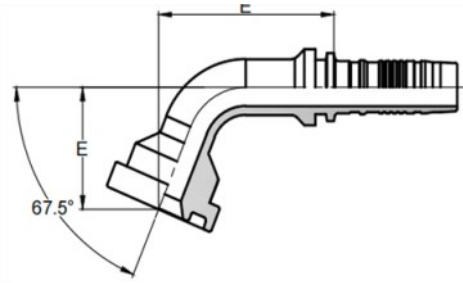

Part Number	Hose Size		Flange		E	F
	Inch	mm	Inch	mm		

G-SERIES

G12-12FL67.5	3/4	19	3/4	38.1	38	68
G12-16FL67.5	3/4	19	1	44.5	40	70
G16-16FL67.5	1	25.4	1	44.5	46	82
G16-20FL67.5	1	25.4	1.1/4	50.8	51	86
G20-20FL67.5	1.1/4	31.8	1.1/4	50.8	54	108
G20-24FL67.5	1.1/4	31.8	1.1/2	60.3	58	110
G24-24FL67.5	1.1/2	38.1	1.1/2	60.3	65	130
G24-32FL67.5	1.1/2	38.1	2	71.4	72	132
G32-32FL67.5	2	50.8	2	71.4	90	153

P-SERIES

P12-12FL67.5	3/4	19	3/4	38.1	38	72
P12-16FL67.5	3/4	19	1	44.5	40	72
P16-16FL67.5	1	25.4	1	44.5	46	86
P16-20FL67.5	1	25.4	1.1/4	50.8	51	88
P20-20FL67.5	1.1/4	31.8	1.1/4	50.8	54	112
P20-24FL67.5	1.1/4	31.8	1.1/2	60.3	58	115
P24-24FL67.5	1.1/2	38.1	1.1/2	60.3	65	134
P24-32FL67.5	1.1/2	38.1	2	71.4	72	136
P32-32FL67.5	2	50.8	2	71.4	90	162

FL90 SAE CODE 61 FLANGE 90° ELBOW

Features

Matching Ferrule: N5300, N5400, N8000, S8000SM, S8900, S9000

Material : Carbon Steel, Stainless Steel

Specification: SAE J516 / ISO 12151-3

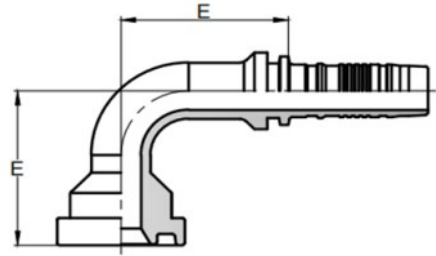

Part Number	Hose Size		Flange		E mm	F mm
	Inch	mm	Inch	mm		
G-SERIES						
G08-08FL90	1/2	12.7	1/2	30.2	38	41
G08-12FL90	1/2	12.7	3/4	38.1	40	43
G10-10FL90	5/8	15.9	5/8	34.0	44	49
G10-12FL90	5/8	15.9	3/4	38.1	45	48
G12-12FL90	3/4	19	3/4	38.1	50	58
G12-16FL90	3/4	19	1	44.5	52	58
G16-16FL90	1	25.4	1	44.5	62	72
G16-20FL90	1	25.4	1.1/4	50.8	63	71
G20-20FL90	1.1/4	31.8	1.1/4	50.8	74	94
G20-24FL90	1.1/4	31.8	1.1/2	60.3	78	94
G24-24FL90	1.1/2	38.1	1.1/2	60.3	85	114
G24-32FL90	1.1/2	38.1	2	71.4	95	114
G32-32FL90	2	50.8	2	71.4	120	136
G32-40FL90	2	50.8	2.1/2	84.1	130	155
P-SERIES						
P12-12FL90	3/4	12.7	3/4	38.1	50	60
P12-16FL90	3/4	12.7	1	44.5	52	60
P16-16FL90	1	25.4	1	44.5	62	76
P16-20FL90	1	25.4	1.1/4	50.8	63	75
P20-20FL90	1.1/4	31.8	1.1/4	50.8	74	97
P20-24FL90	1.1/4	31.8	1.1/2	60.3	78	97
P24-24FL90	1.1/2	38.1	1.1/2	60.3	85	118
P24-32FL90	1.1/2	38.1	2	71.4	95	118
P32-32FL90	2	50.8	2	71.4	120	145

FL90L SAE CODE 61 FLANGE 90° ELBOW - LONG DROP

Features

Matching Ferrule: S8000SM, S8900, S9000

Material : Carbon Steel, Stainless Steel

Specification: SAE J516 / ISO 12151-3

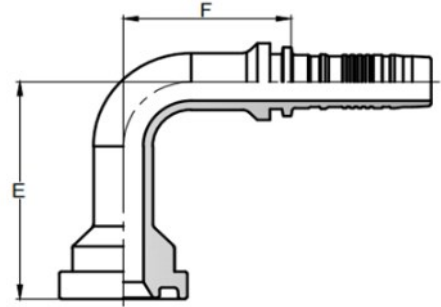

Part Number	Hose Size		Flange		E	F
	Inch	mm	Inch	mm		

P-SERIES

P12-12FL90-L4	3/4	19	3/4	38.1	100	60
P12-12FL90-L5	3/4	19	3/4	38.1	125	60
P12-12FL90-L6	3/4	19	3/4	38.1	150	60
P12-16FL90-L4	3/4	19	1	44.5	100	60
P12-16FL90-L6	3/4	19	1	44.5	150	60
P16-16FL90-L4	1	25.4	1	44.5	100	76
P16-16FL90-L5	1	25.4	1	44.5	125	76
P16-16FL90-L6	1	25.4	1	44.5	150	76
P16-16FL90-L8	1	25.4	1	44.5	200	76
P16-20FL90-L4	1	25.4	1.1/4	50.8	100	75
P16-20FL90-L6	1	25.4	1.1/4	50.8	150	75
P20-20FL90-L6	1.1/4	31.8	1.1/4	50.8	150	97
P20-20FL90-L7	1.1/4	31.8	1.1/4	50.8	175	97
P20-20FL90-L8	1.1/4	31.8	1.1/4	50.8	200	97
P20-24FL90-L6	1.1/4	31.8	1.1/2	60.3	150	97
P20-24FL90-L9	1.1/4	31.8	1.1/2	60.3	225	97
P24-24FL90-L6	1.1/2	38.1	1.1/2	60.3	150	118
P24-24FL90-L9	1.1/2	38.1	1.1/2	60.3	225	118
P32-32FL90-L8	2	50.8	2	71.4	200	160
P32-32FL90-L10	2	50.8	2	71.4	250	160
P32-32FL90-L11	2	50.8	2	71.4	275	160

PART D
G/P Series

FL110 SAE CODE 61 FLANGE 110° ELBOW

Features

Matching Ferrule: S8000SM, S8900, S9000

Material : Carbon Steel, Stainless Steel

Specification: SAE J516 / ISO 12151-3

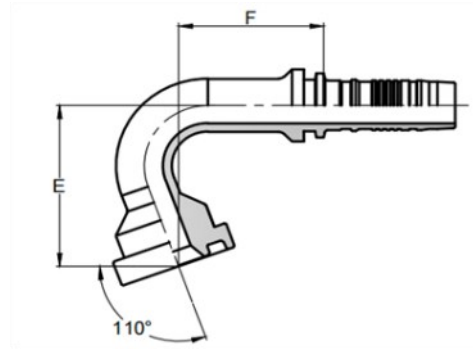

PART D
G/P Series

Part Number	Hose Size		Flange		E mm	F mm
	Inch	mm	Inch	mm		
P-SERIES						
P12-12FL110	3/4	19	3/4	38.1	63.5	64
P16-16FL110	1	25.4	1	44.5	70	77
F20-20FL110	1.1/4	31.8	1.1/4	50.8	90	108

FL135 SAE CODE 61 FLANGE 135° ELBOW

Features

Matching Ferrule: S8000SM, S8900, S9000

Material : Carbon Steel, Stainless Steel

Specification: SAE J516 / ISO 12151-3

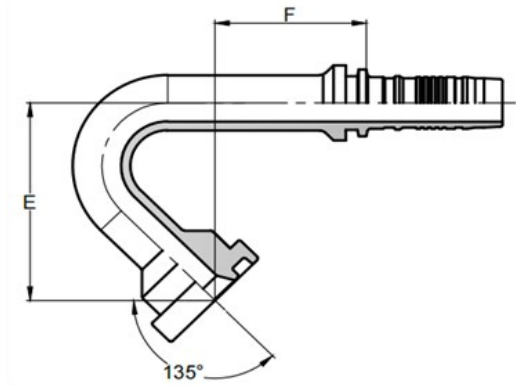

Part Number	Hose Size		Flange		E mm	F mm
	Inch	mm	Inch	mm		
P-SERIES						
P12-12FL135	3/4	19	3/4	38.1	75	48
P16-16FL135	1	25.4	1	44.5	90	72
P20-20FL135	1.1/4	31.8	1.1/4	50.8	101	81

FLH SAE CODE 62 FLANGE

Features

Matching Ferrule: S8000SM, S8900, S9000

Material : Carbon Steel, Stainless Steel

Specification: SAE J516 / ISO 12151-3

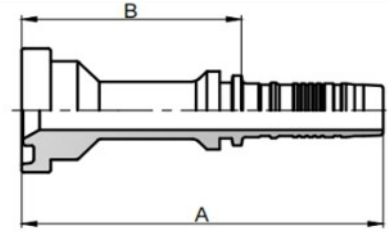

Part Number	Hose Size		Flange		A mm	B mm
	Inch	mm	Inch	mm		
P-SERIES						
P12-12FLH	3/4	19	3/4	41.3	115	62.5
P12-16FLH	3/4	19	1	47.65	115	62.5
P16-16FLH	1	25.4	1	47.65	125	63
P16-20FLH	1	25.4	1.1/4	54.0	130	68
P20-20FLH	1.1/4	31.8	1.1/4	54.0	150	76
P20-24FLH	1.1/4	31.8	1.1/2	63.5	160	86
P24-24FLH	1.1/2	38.1	1.1/2	63.5	166	90
P24-32FLH	1.1/2	38.1	2	79.4	166	90
P32-32FLH	2	50.8	2	79.4	190	102

FLH45 SAE CODE 62 FLANGE 45° ELBOW

Features

Matching Ferrule: S8000SM, S8900, S9000

Material : Carbon Steel, Stainless Steel

Specification: SAE J516 / ISO 12151-3

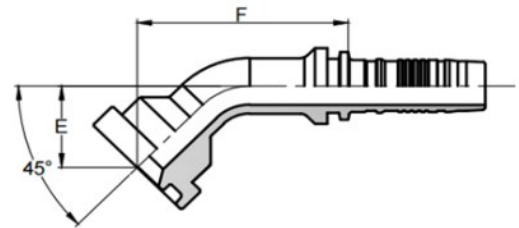

Part Number	Hose Size		Flange		E mm	F mm
	Inch	mm	Inch	mm		
P-SERIES						
P12-12FLH45	3/4	19	3/4	41.3	27	72.5
P12-16FLH45	3/4	19	1	47.65	27	72.5
P16-16FLH45	1	25.4	1	47.65	32	92.5
P16-20FLH45	1	25.4	1.1/4	54.0	38	98.5
P20-20FLH45	1.1/4	31.8	1.1/4	54.0	38	118
P20-24FLH45	1.1/4	31.8	1.1/2	63.5	44	125
P24-24FLH45	1.1/2	38.1	1.1/2	63.5	47	138
P24-32FLH45	1.1/2	38.1	2	79.4	52	150
P32-32FLH45	2	50.8	2	79.4	56	175

FLH45L SAE CODE 62 FLANGE 45° ELBOW - LONG DROP

Features

Matching Ferrule: S8000SM, S8900, S9000

Material : Carbon Steel, Stainless Steel

Specification: SAE J516 / ISO 12151-3

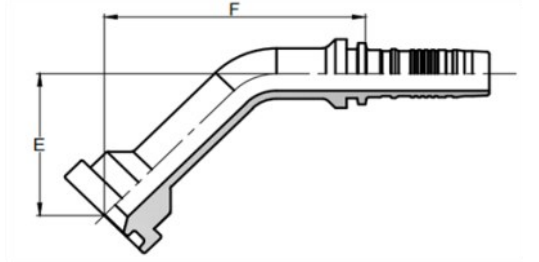

Part Number	Hose Size		Flange		E mm	F mm
	Inch	mm	Inch	mm		
P-SERIES						
P12-12FLH45-L4	3/4	19	3/4	41.3	71	116
P12-12FLH45-L5	3/4	19	3/4	41.3	88	134
P12-12FLH45-L6	3/4	19	3/4	41.3	106	152
P12-16FLH45-L4	3/4	19	1	47.65	71	116
P12-16FLH45-L6	3/4	19	1	47.65	106	152
P16-16FLH45-L4	1	25.4	1	47.65	71	132
P16-16FLH45-L5	1	25.4	1	47.65	88	150
P16-16FLH45-L6	1	25.4	1	47.65	106	168
P16-20FLH45-L6	1	25.4	1.1/4	63.5	106	168
P20-20FLH45-L6	1.1/4	31.8	1.1/4	63.5	106	186

PART D
G/P Series

FLH22.5 SAE CODE 62 FLANGE 22.5° ELBOW

Features

Matching Ferrule: S8000SM, S8900, S9000

Material : Carbon Steel, Stainless Steel

Specification: SAE J516 / ISO 12151-3

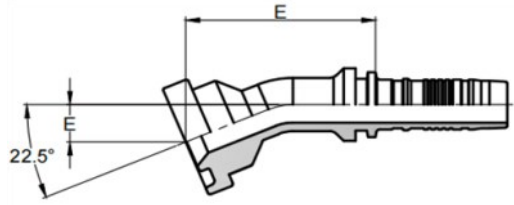

PART D
G/P Series

Part Number	Hose Size		Flange		A mm	B mm
	Inch	mm	Inch	mm		
P-SERIES						
P12-12FLH22.5	3/4	19	3/4	41.3	14.5	83
P16-16FLH22.5	1	25.4	1	47.65	16	95
P20-20FLH22.5	1.1/4	31.8	1.1/4	54.0	18	120
P24-24FLH22.5	1.1/2	38.1	1.1/2	63.5	20.5	135
P32-32FLH22.5	2	50.8	2	79.4	22	168

FLH67.5 SAE CODE 62 FLANGE 67.5° ELBOW

Features

Matching Ferrule: S8000SM, S8900, S9000

Material : Carbon Steel, Stainless Steel

Specification: SAE J516 / ISO 12151-3

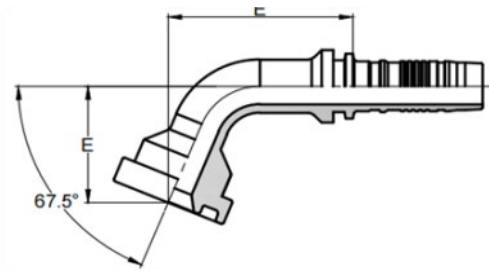

Part Number	Hose Size		Flange		E mm	F mm
	Inch	mm	Inch	mm		
P-SERIES						
P12-12FLH67.5	3/4	19	3/4	41.3	42	70
P16-16FLH67.5	1	25.4	1	47.65	51	88
P20-20FLH67.5	1.1/4	31.8	1.1/4	54.0	64	115
P24-24FLH67.5	1.1/2	38.1	1.1/2	63.5	74	140
P32-32FLH67.5	2	50.8	2	79.4	90	161

FLH90 SAE CODE 62 FLANGE 90° ELBOW

Features

Matching Ferrule: S8000SM, S8900, S9000

Material : Carbon Steel, Stainless Steel

Specification: SAE J516 / ISO 12151-3

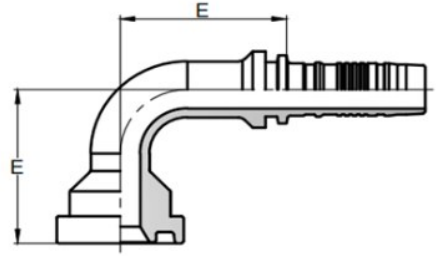

Part Number	Hose Size		Flange		E mm	F mm
	Inch	mm	Inch	mm		
P-SERIES						
P12-12FLH90	3/4	19	3/4	41.3	58	60
P12-16FLH90	3/4	19	1	47.65	58	60
P16-16FLH90	1	25.4	1	47.65	70	76
P16-20FLH90	1	25.4	1.1/4	54.0	70	76
P20-20FLH90	1.1/4	31.8	1.1/4	54.0	90	97
P20-24FLH90	1.1/4	31.8	1.1/2	63.5	90	97
P24-24FLH90	1.1/2	38.1	1.1/2	63.5	104	118
P24-32FLH90	1.1/2	38.1	2	79.4	104	118
P32-32FLH90	2	50.8	2	79.4	138	147

PART D
G/P Series

FLH90L SAE CODE 62 FLANGE 90° ELBOW - LONG DROP

Features

Matching Ferrule: S8000SM, S8900, S9000

Material : Carbon Steel, Stainless Steel

Specification: SAE J516 / ISO 12151-3

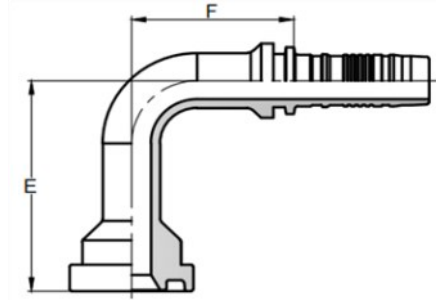

Part Number	Hose Size		Flange		E mm	F mm
	Inch	mm	Inch	mm		

P-SERIES

P12-12FLH90-L4	3/4	19	3/4	41.3	100	60
P12-12FLH90-L5	3/4	19	3/4	41.3	125	60
P12-12FLH90-L6	3/4	19	3/4	41.3	150	60
P12-16FLH90-L4	3/4	19	1	47.65	100	60
P12-16FLH90-L5	3/4	19	1	47.65	125	60
P12-16FLH90-L6	3/4	19	1	47.65	150	60
P16-16FLH90-L4	1	25.4	1	47.65	100	76
P16-16FLH90-L5	1	25.4	1	47.65	125	76
P16-16FLH90-L6	1	25.4	1	47.65	150	76
P16-20FLH90-L6	1	25.4	1.1/4	54.0	150	76
P16-20FLH90-L7.5	1	25.4	1.1/4	54.0	190	76
P20-20FLH90-L6	1.1/4	31.8	1.1/4	54.0	150	97
P20-20FLH90-L7.5	1.1/4	31.8	1.1/4	54.0	190	97
P24-24FLH90-L6	1.1/2	38.1	1.1/2	63.5	150	118
P24-24FLH90-L8	1.1/2	38.1	1.1/2	63.5	200	118
P24-24FLH90-L9	1.1/2	38.1	1.1/2	63.5	225	118
P32-32FLH90-L8	2	50.8	2	79.4	200	147
P32-32FLH90-L10	2	50.8	2	79.4	250	147
P32-32FLH90-L11	2	50.8	2	79.4	275	147

FLC CATERPILLAR FLANGE

Features

Matching Ferrule: S8000SM, S8900, S9000

Material : Carbon Steel, Stainless Steel

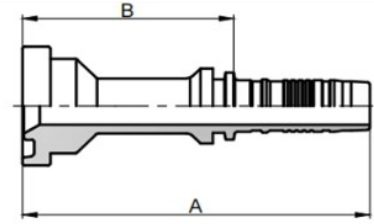

Part Number	Hose Size		Flange		A	B
	Inch	mm	Inch	mm		
P-SERIES						
P12-12FLC	3/4	19	3/4	41.3	115	62.5
P12-16FLC	3/4	19	1	47.65	115	62.5
P16-16FLC	1	25.4	1	47.65	125	63
P16-20FLC	1	25.4	1.1/4	54.0	130	68
P20-20FLC	1.1/4	31.8	1.1/4	54.0	150	76
P20-24FLC	1.1/4	31.8	1.1/2	63.5	160	86
P24-24FLC	1.1/2	38.1	1.1/2	63.5	166	90
P24-32FLC	1.1/2	38.1	2	79.4	166	90
P32-32FLC	2	50.8	2	79.4	190	102

PART D
G/P Series

FLC45 CATERPILLAR FLANGE 45° ELBOW

Features

Matching Ferrule: S8000SM, S8900, S9000

Material : Carbon Steel, Stainless Steel

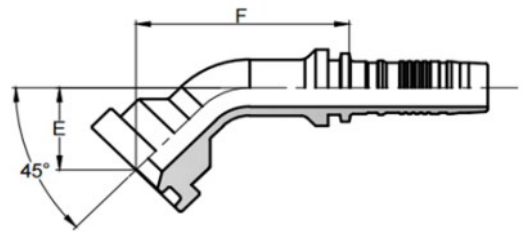

Part Number	Hose Size		Flange		E	F
	Inch	mm	Inch	mm		
P-SERIES						
P12-12FLC45	3/4	19	3/4	41.3	27	72.5
P12-16FLC45	3/4	19	1	47.65	27	72.5
P16-16FLC45	1	25.4	1	47.65	32	92.5
P16-20FLC45	1	25.4	1.1/4	54.0	38	98.5
P20-20FLC45	1.1/4	31.8	1.1/4	54.0	38	118
P20-24FLC45	1.1/4	31.8	1.1/2	63.5	44	125
P24-24FLC45	1.1/2	38.1	1.1/2	63.5	47	138
P24-32FLC45	1.1/2	38.1	2	79.4	52	150
P32-32FLC45	2	50.8	2	79.4	56	175

FLC90L CATERPILLAR FLANGE 90° ELBOW

Features

Matching Ferrule: S8000SM, S8900, S9000

Material : Carbon Steel, Stainless Steel

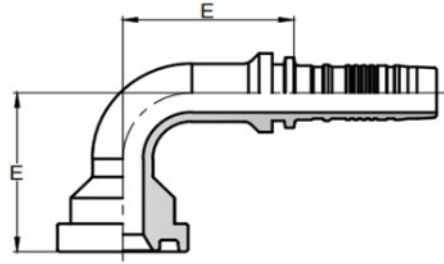

Part Number	Hose Size		Flange		E mm	F mm
	Inch	mm	Inch	mm		
P-SERIES						
P12-12FLH90	3/4	19	3/4	41.3	58	60
P12-16FLH90	3/4	19	1	47.65	58	60
P16-16FLH90	1	25.4	1	47.65	70	76
P16-20FLH90	1	25.4	1.1/4	54.0	70	76
P20-20FLH90	1.1/4	31.8	1.1/4	54.0	90	97
P20-24FLH90	1.1/4	31.8	1.1/2	63.5	90	97
P24-24FLH90	1.1/2	38.1	1.1/2	63.5	104	118
P24-32FLH90	1.1/2	38.1	2	79.4	104	118
P32-32FLH90	2	50.8	2	79.4	138	147

PART D
G/P Series

HT-FLH (EXTREME HI IMPULSE) SAE CODE 62 FLANGE

Features

Matching Ferrule: S9000-L

Material : Carbon Steel, Stainless Steel

Specification: SAE J516 / ISO 12151-3

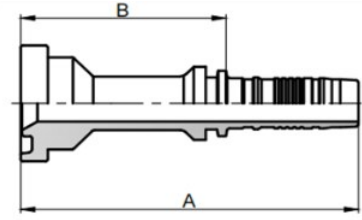

Part Number	Hose Size		Flange		A	B
	Inch	mm	Inch	mm		
P-SERIES						
HT20-20FLH	1.1/4	31.8	1.1/4	54.0	160	73
HT24-24FLH	1.1/2	38.1	1.1/2	63.5	180	72
HT32-32FLH	2	50.8	2	79.4	250	126

PART D
G/P Series

HT-FLH45 (EXTREME HI IM PULSE) SAE CODE 62 FLANGE 45° ELBOW

Features

Matching Ferrule: S9000-L

Material : Carbon Steel, Stainless Steel

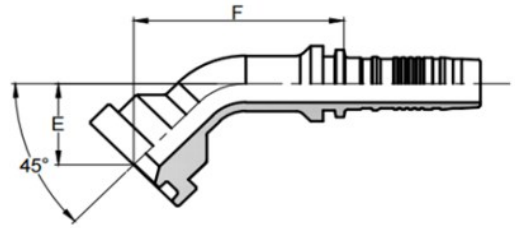

Part Number	Hose Size		Flange		E	F
	Inch	mm	Inch	mm		
P-SERIES						
HT20-20FLH45	1.1/4	31.8	1.1/4	54.0	40	120
HT24-24FLH45	1.1/2	38.1	1.1/2	63.5	44	135
HT32-32FLH45	2	50.8	2	79.4	58	175

HT-FLH90 (EXTREME HI IMPULSE) SAE CODE 62 FLANGE 90° ELBOW

Features

Matching Ferrule: S9000-L

Material : Carbon Steel, Stainless Steel

Specification: SAE J516 / ISO 12151-3

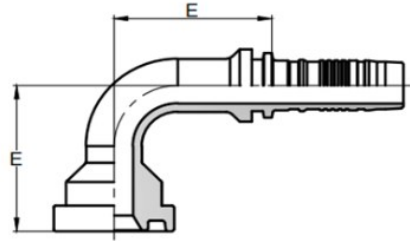

PART D
G/P Series

Part Number	Hose Size		Flange		E mm	F mm
	Inch	mm	Inch	mm		
P-SERIES						
HT20-20FLH90	1.1/4	31.8	1.1/4	54.0	86	100
HT24-24FLH90	1.1/2	38.1	1.1/2	63.5	97	120
HT32-32FLH90	2	50.8	2	79.4	125	155

MDKOL MALE DIN-L 24° CONE

Features

Matching Ferrule: N5300, N5400, N8000, S8000SM, S8900, S9000

Material : Carbon Steel, Stainless Steel

Specification: ISO 12151-2

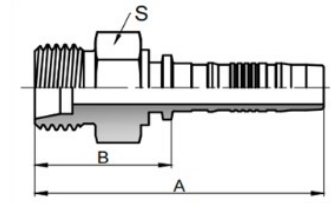

Part Number	Hose Size		Thread metric	Tube mm	A mm	B mm	S mm
	Inch	mm					
G-SERIES							
G04-06MDKOL	1/4	6.4	M12x1.5	6	51	23	14
G04-08MDKOL	1/4	6.4	M14x1.5	8	52	26	17
G04-10MDKOL	1/4	6.4	M16x1.5	10	52	26	17
G06-10MDKOL	3/8	9.5	M16x1.5	10	55	25	17
G06-12MDKOL	3/8	9.5	M18x1.5	12	56	26	19
G06-15MDKOL	3/8	9.5	M22x1.5	15	57	27	24
G08-15MDKOL	1/2	12.7	M22x1.5	15	62	29	24
G08-18MDKOL	1/2	12.7	M26x1.5	18	62	29	27
G10-18MDKOL	5/8	15.9	M26x1.5	18	65	29	27
G12-22MDKOL	3/4	19	M30x2.0	22	74	34	32
G16-28MDKOL	1	25.4	M36x2.0	28	87	36	41
G20-35MDKOL	1.1/4	31.8	M45x2.0	35	98	40	46
G24-42MDKOL	1.1/2	38.1	M52x2.0	42	106	42	55
P-SERIES							
P12-22MDKOL	3/4	19	M30x2.0	22	90	38	32
P16-28MDKOL	1	25.4	M36x2.0	28	100	38	41
P20-35MDKOL	1.1/4	31.8	M45x2.0	35	118	46	46
P24-42MDKOL	1.1/2	38.1	M52x2.0	42	124	48	55

FDKOL FEMALE DIN-L 24° CONE (O-RING) SWIVEL

Features

Matching Ferrule: N5300, N5400, N8000, S8000SM, S8900, S9000

Material : Carbon Steel, Stainless Steel

Specification: ISO 12151-2

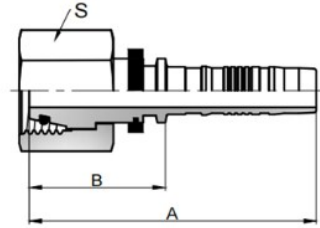

Part Number	Hose Size		Thread metric	Tube mm	A mm	B mm	S mm
	Inch	mm					

G-SERIES

G04-06FDKOL	1/4	6.4	M12x1.5	6	50	23	14
G04-08FDKOL	1/4	6.4	M14x1.5	8	53	25	17
G04-10FDKOL	1/4	6.4	M16x1.5	10	53	25	19
G04-12FDKOL	1/4	6.4	M18x1.5	12	54	26	22
G05-10FDKOL	5/16	7.9	M16x1.5	10	55	27	19
G05-12FDKOL	5/16	7.9	M18x1.5	12	55	27	22
G06-10FDKOL	3/8	9.5	M16x1.5	10	55	25	19
G06-12FDKOL	3/8	9.5	M18x1.5	12	57	27	22
G06-15FDKOL	3/8	9.5	M22x1.5	15	56	26	27
G08-12FDKOL	1/2	12.7	M18x1.5	12	58	25	22
G08-15FDKOL	1/2	12.7	M22x1.5	15	60	27	27
G08-18FDKOL	1/2	12.7	M26x1.5	18	62	29	32
G10-18FDKOL	5/8	15.9	M26x1.5	18	68	30	32
G10-22FDKOL	5/8	15.9	M30x2.0	22	72	36	36
G12-18FDKOL	3/4	19	M26x1.5	18	68.5	28	32
G12-22FDKOL	3/4	19	M30x2.0	22	74	34	36
G12-28FDKOL	3/4	19	M36x2.0	28	75	35	41
G16-28FDKOL	1	25.4	M36x2.0	28	85	44	41
G16-35FDKOL	1	25.4	M45x2.0	35	88	37	50
G20-35FDKOL	1.1/4	31.8	M45x2.0	35	98	41	50
G20-42FDKOL	1.1/4	31.8	M52x2.0	42	95	37	60
G24-42FDKOL	1.1/2	38.1	M52x2.0	42	105	37	60

P-SERIES

P12-22FDKOL	3/4	19	M30x2.0	22	86	36	36
P16-28FDKOL	1	25.4	M36x2.0	28	96	34	41
P20-35FDKOL	1.1/4	31.8	M45x2.0	35	115	41	50
P24-42FDKOL	1.1/2	38.1	M52x2.0	42	118	42	60

FDKOL45 FEMALE DIN-L 24° CONE (O-RING) SWIVEL 45° ELBOW
Features

Matching Ferrule: 5300N5300, N5400, N8000, S8000SM, S8900, S9000

Material : Carbon Steel, Stainless Steel

Specification: ISO 12151-2

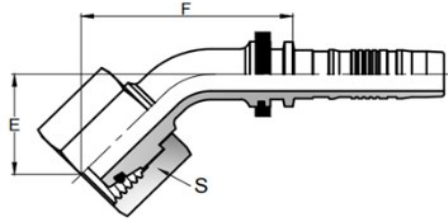

Part Number	Hose Size		Thread metric	Tube mm	A mm	B mm	S mm
	Inch	mm					
G-SERIES							
G04-06FDKOL45	1/4	6.4	M12x1.5	6	16	40	14
G04-08FDKOL45	1/4	6.4	M14x1.5	8	16	40	17
G04-10FDKOL45	1/4	6.4	M16x1.5	10	17	43	19
G04-12FDKOL45	1/4	6.4	M18x1.5	12	18.5	43	22
G05-10FDKOL45	5/16	7.9	M16x1.5	10	17	45	19
G05-12FDKOL45	5/16	7.9	M18x1.5	12	18.5	45	22
G06-10FDKOL45	3/8	9.5	M16x1.5	10	19	50	19
G06-12FDKOL45	3/8	9.5	M18x1.5	12	18.5	48	22
G06-15FDKOL45	3/8	9.5	M22x1.5	15	20	50	27
G08-12FDKOL45	1/2	12.7	M18x1.5	12	21.5	54	22
G08-15FDKOL45	1/2	12.7	M22x1.5	15	20	56	27
G08-18FDKOL45	1/2	12.7	M26x1.5	18	22	56	32
G10-18FDKOL45	5/8	15.9	M26x1.5	18	23.5	63	32
G10-22FDKOL45	5/8	15.9	M30x2.0	22	26	70	36
G12-18FDKOL45	3/4	19	M26x1.5	18	27	75	32
G12-22FDKOL45	3/4	19	M30x2.0	22	26.5	75	36
G12-28FDKOL45	3/4	19	M36x2.0	28	29	76	41
G16-28FDKOL45	1	25.4	M36x2.0	28	32	90	41
G16-35FDKOL45	1	25.4	M45x2.0	35	34	93	50
G20-35FDKOL45	1.1/4	31.8	M45x2.0	35	38	108	50
G20-42FDKOL45	1.1/4	31.8	M52x2.0	42	38	108	60
G24-42FDKOL45	1.1/2	38.1	M52x2.0	42	44.5	125	60
P-SERIES							
P12-22FDKOL45	3/4	19	M30x2.0	22	28.5	78	36
P16-28FDKOL45	1	25.4	M36x2.0	28	32	92	41
P20-35FDKOL45	1.1/4	31.8	M45x2.0	35	38	118	50
P24-42FDKOL45	1.1/2	38.1	M52x2.0	42	44	140	60

FDKOL90 FEMALE DIN-L 24° CONE (O-RING) SWIVEL 90° ELBOW

Features

Matching Ferrule: 5300N5300, N5400, N8000, S8000SM, S8900, S9000

Material : Carbon Steel, Stainless Steel

Specification: ISO 12151-2

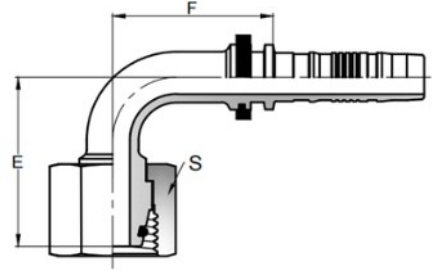

Part Number	Hose Size		Thread metric	Tube mm	E mm	F mm	S mm
	Inch	mm					

G-SERIES

G04-06FDKOL90	1/4	6.4	M12x1.5	6	30	32	14
G04-08FDKOL90	1/4	6.4	M14x1.5	8	30.5	32	17
G04-10FDKOL90	1/4	6.4	M16x1.5	10	33	33	19
G04-12FDKOL90	1/4	6.4	M18x1.5	12	32	32	22
G05-10FDKOL90	5/16	7.9	M16x1.5	10	33	35	19
G05-12FDKOL90	5/16	7.9	M18x1.5	12	34	38	22
G06-10FDKOL90	3/8	9.5	M16x1.5	10	35	36	19
G06-12FDKOL90	3/8	9.5	M18x1.5	12	34	40	22
G06-15FDKOL90	3/8	9.5	M22x1.5	15	36	40	27
G08-12FDKOL90	1/2	12.7	M18x1.5	12	43	45	22
G08-15FDKOL90	1/2	12.7	M22x1.5	15	40	47	27
G08-18FDKOL90	1/2	12.7	M26x1.5	18	43	49	32
G10-18FDKOL90	5/8	15.9	M26x1.5	18	45	52	32
G10-22FDKOL90	5/8	15.9	M30x2.0	22	50	56	36
G12-18FDKOL90	3/4	19	M26x1.5	18	54	60	32
G12-22FDKOL90	3/4	19	M30x2.0	22	54	60	36
G12-28FDKOL90	3/4	19	M36x2.0	28	57	60	41
G16-28FDKOL90	1	25.4	M36x2.0	28	65	82	41
G16-35FDKOL90	1	25.4	M45x2.0	35	70	82	50
G20-35FDKOL90	1.1/4	31.8	M45x2.0	35	80	98	50
G20-42FDKOL90	1.1/4	31.8	M52x2.0	42	80	98	60
G24-42FDKOL90	1.1/2	38.1	M52x2.0	42	90	110	60

P-SERIES

P12-22FDKOL90	3/4	19	M30x2.0	22	56	60	36
P16-28FDKOL90	1	25.4	M36x2.0	28	68.5	76	41
P20-35FDKOL90	1.1/4	31.8	M45x2.0	35	80	97	50
P24-42FDKOL90	1.1/2	38.1	M52x2.0	42	95	118	60

MDKOS MALE DIN-S 24° CONE

Features

Matching Ferrule: N5300, N5400, N8000, S8000SM, S8900, S9000

Material : Carbon Steel, Stainless Steel

Specification: ISO 12151-2

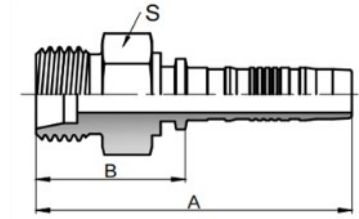

Part Number	Hose Size		Thread metric	Tube mm	A mm	B mm	S mm
	Inch	mm					
G-SERIES							
G04-08MDKOS	1/4	6.4	M16x1.5	8	55	27	17
G04-10MDKOS	1/4	6.4	M18x1.5	10	55	27	19
G05-12MDKOS	5/16	7.9	M20x1.5	12	55	27	22
G06-12MDKOS	3/8	9.5	M20x1.5	12	57	27	22
G06-14MDKOS	3/8	9.5	M22x1.5	14	60	30	24
G08-14MDKOS	1/2	12.7	M22x1.5	14	63	30	24
G08-16MDKOS	1/2	12.7	M24x1.5	16	64	31	27
G10-20MDKOS	5/8	15.9	M30x2.0	20	72	36	32
G12-20MDKOS	3/4	19	M30x2.0	20	78	37	32
G12-25MDKOS	3/4	19	M36x2.0	25	81.5	41	41
G16-25MDKOS	1	25.4	M36x2.0	25	94	43	41
G16-30MDKOS	1	25.4	M42x2.0	30	95	44	55
P-SERIES							
P12-20MDKOS	3/4	19	M30x2.0	20	90	48	32
P12-25MDKOS	3/4	19	M36x2.0	25	92	42	41
P16-25MDKOS	1	25.4	M36x2.0	25	106	44	41
P16-30MDKOS	1	25.4	M42x2.0	30	108	46	46
P20-30MDKOS	1.1/4	31.8	M42x2.0	30	122	48	46
P24-38MDKOS	1.1/2	38.1	M52x2.0	38	125	51	55

FDKOS FEMALE DIN-S 24° CONE (O-RING) SWIVEL

Features

Matching Ferrule: N5300, N5400, N8000, S8000SM, S8900, S9000

Material : Carbon Steel, Stainless Steel

Specification: ISO 12151-2

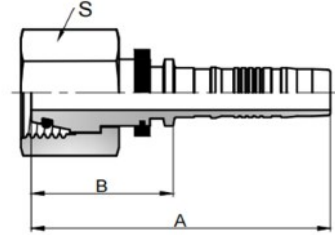

Part Number	Hose Size		Thread metric	Tube mm	A mm	B mm	S mm
	Inch	mm					

G-SERIES

G04-06FDKOS	1/4	6.4	M14x1.5	6	53	25	17
G04-08FDKOS	1/4	6.4	M16x1.5	8	53	25	19
G04-10FDKOS	1/4	6.4	M18x1.5	10	53	25	22
G05-12FDKOS	5/16	7.9	M20x1.5	12	55	30	27
G06-12FDKOS	3/8	9.5	M20x1.5	12	57	27	27
G06-14FDKOS	3/8	9.5	M22x1.5	14	57	27	27
G08-14FDKOS	1/2	12.7	M22x1.5	14	60	27	27
G08-16FDKOS	1/2	12.7	M24x1.5	16	62	29	30
G10-20FDKOS	5/8	15.9	M30x2.0	20	72	35	36
G12-20FDKOS	3/4	19	M30x2.0	20	74	34	36
G12-25FDKOS	3/4	19	M36x2.0	25	76	36	46
G16-25FDKOS	1	25.4	M36x2.0	25	88	37	46
G16-30FDKOS	1	25.4	M42x2.0	30	88	37	50
G20-38FDKOS	1.1/4	31.8	M52x2.0	38	98	40	60
G24-38FDKOS	1.1/2	38.1	M52x2.0	38	104	40	60

P-SERIES

P12-20FDKOS	3/4	19	M30x2.0	20	86	36	36
P12-25FDKOS	3/4	19	M36x2.0	25	86	36	46
P16-25FDKOS	1	25.4	M36x2.0	25	96	34	46
P16-30FDKOS	1	25.4	M42x2.0	30	100	38	50
P20-30FDKOS	1.1/4	31.8	M42x2.0	30	116	42	50
P24-38FDKOS	1.1/2	38.1	M52x2.0	38	118	44	60

FDKOS45 FEMALE DIN-S 24° CONE (O-RING) SWIVEL 45° ELBOW

Features

Matching Ferrule: 5300N5300, N5400, N8000, S8000SM, S8900, S9000

Material : Carbon Steel, Stainless Steel

Specification: ISO 12151-2

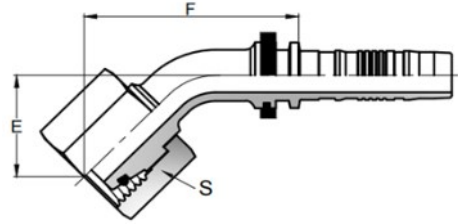

Part Number	Hose Size		Thread metric	Tube mm	A mm	B mm	S mm
	Inch	mm					
G-SERIES							
G04-06FDKOS45	1/4	6.4	M14x1.5	6	16	40	17
G04-08FDKOS45	1/4	6.4	M16x1.5	8	17	43	19
G04-10FDKOS45	1/4	6.4	M18x1.5	10	18	45	22
G05-12FDKOS45	5/16	7.9	M20x1.5	12	19	45	27
G06-12FDKOS45	3/8	9.5	M20x1.5	12	19	48	27
G06-14FDKOS45	3/8	9.5	M22x1.5	14	20	50	27
G08-14FDKOS45	1/2	12.7	M22x1.5	14	20	56	27
G08-16FDKOS45	1/2	12.7	M24x1.5	16	21	56	30
G10-20FDKOS45	5/8	15.9	M30x2.0	20	26	70	36
G12-20FDKOS45	3/4	19	M30x2.0	20	28	75	36
G12-25FDKOS45	3/4	19	M36x2.0	25	29	76	46
G16-25FDKOS45	1	25.4	M36x2.0	25	33	90	46
G16-30FDKOS45	1	25.4	M42x2.0	30	35	95	50
G20-38FDKOS45	1.1/4	31.8	M52x2.0	38	38	112	60
G24-38FDKOS45	1.1/2	38.1	M52x2.0	38	45	125	60
P-SERIES							
P12-20FDKOS45	3/4	19	M30x2.0	20	28.5	78	36
P12-25FDKOS45	3/4	19	M36x2.0	25	32	80	46
P16-25FDKOS45	1	25.4	M36x2.0	25	32	92	46
P16-30FDKOS45	1	25.4	M42x2.0	30	32	92	50
P20-30FDKOS45	1.1/4	31.8	M42x2.0	30	38	118	50
P24-38FDKOS45	1.1/2	38.1	M52x2.0	38	38	118	60

FDKOS90 FEMALE DIN-S 24° CONE (O-RING) SWIVEL 90° ELBOW

Features

Matching Ferrule: N5300, N5400, N8000, S8000SM, S8900, S9000

Material : Carbon Steel, Stainless Steel

Specification: ISO 12151-2

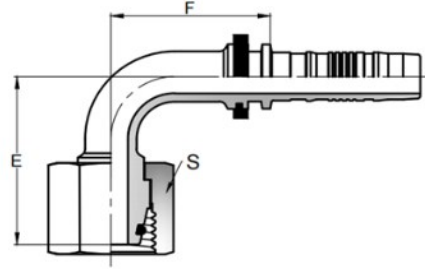

Part Number	Hose Size		Thread metric	Tube mm	E mm	F mm	S mm
	Inch	mm					

G-SERIES

G04-06FDKOS90	1/4	6.4	M14x1.5	6	30.5	32	17
G04-08FDKOS90	1/4	6.4	M16x1.5	8	33	33	19
G04-10FDKOS90	1/4	6.4	M18x1.5	10	33	33	22
G05-12FDKOS90	5/16	7.9	M20x1.5	12	34	35	27
G06-12FDKOS90	3/8	9.5	M20x1.5	12	34	40	27
G06-14FDKOS90	3/8	9.5	M22x1.5	14	36	40	27
G08-14FDKOS90	1/2	12.7	M22x1.5	14	40	47	27
G08-16FDKOS90	1/2	12.7	M24x1.5	16	43	48	30
G10-20FDKOS90	5/8	15.9	M30x2.0	20	50	52	36
G12-20FDKOS90	3/4	19	M30x2.0	20	56	60	36
G12-25FDKOS90	3/4	19	M36x2.0	25	57	60	46
G16-25FDKOS90	1	25.4	M36x2.0	25	67	83	46
G16-30FDKOS90	1	25.4	M42x2.0	30	70	83	50
G20-38FDKOS90	1.1/4	31.8	M52x2.0	38	80	92	60
G24-38FDKOS90	1.1/2	38.1	M52x2.0	38	90	110	60

P-SERIES

P12-20FDKOS90	3/4	19	M30x2.0	20	56	60	36
P12-25FDKOS90	3/4	19	M36x2.0	25	56	60	46
P16-25FDKOS90	1	25.4	M36x2.0	25	68	76	46
P16-30FDKOS90	1	25.4	M42x2.0	30	70	76	50
P20-30FDKOS90	1.1/4	31.8	M42x2.0	30	80	97	50
P24-38FDKOS90	1.1/2	38.1	M52x2.0	38	80	97	60

MT MALE BSP TAPER (BSPT)
Features

Matching Ferrule: 5300N5300, N5400, N8000, S8000SM, S8900, S9000

Material : Carbon Steel, Stainless Steel

Specification: JIS B8363

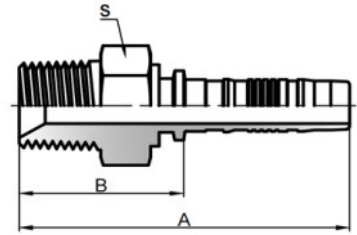

Part Number	Hose Size		Thread	A	B	S
	Inch	mm				
G-SERIES						
G04-02MT	1/4	6.4	1/8-28	51	22	14
G04-04MT	1/4	6.4	1/4-19	55	27	17
G04-06MT	1/4	6.4	3/8-19	58.5	28.5	19
G06-04MT	3/8	9.5	1/4-19	56.5	26	17
G06-06MT	3/8	9.5	3/8-19	59	28.5	19
G06-08MT	3/8	9.5	1/2-14	64.5	34	22
G08-06MT	1/2	12.7	3/8-19	63.5	30.5	22
G08-08MT	1/2	12.7	1/2-14	68	35	22
G12-08MT	3/4	19	1/2-14	78	38	27
G12-12MT	3/4	19	3/4-14	78	38	27
G12-16MT	3/4	19	1-11	86	45	35
G16-16MT	1	25.4	1-11	98	47	35
G20-20MT	1.1/4	31.8	1.1/4-11	110	52	46
G24-24MT	1.1/2	38.1	1.1/2-11	120	55	50
G32-32MT	2	50.8	2-11	134	64	65
P-SERIES						
P12-12MT	3/4	19	3/4-14	92	40	30
P16-16MT	1	25.4	1-11	108	44	36
P20-20MT	1.1/4	31.8	1.1/4-11	128	54	46
P24-24MT	1.1/2	38.1	1.1/2-11	135	58	50
P32-32MT	2	50.8	2-11	160	72	65

MB MALE BSP PARALLEL 60° CONE (BSPP)

Features

Matching Ferrule: N5300, N5400, N8000, S8000SM

Material : Carbon Steel, Stainless Steel

Specification: ISO 12151-6

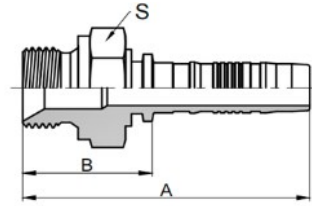

Part Number	Hose Size		Thread	A	B	S
	Inch	mm				
G-SERIES						
G04-04MB	1/4	6.4	1/4-19	53	25	19
G06-06MB	3/8	9.5	3/8-19	59	29	22
G08-08MB	1/2	12.7	1/2-14	66	33	27
G10-10MB	5/8	15.9	5/8-14	72	36	30
G12-12MB	3/4	19	3/4-14	77	37	32
G16-16MB	2	50.8	2-11	94	43	41

FBH FEMALE BSP PARALLEL 60° CONE SWIVEL (BSPP - DOUBLE HEX)

Features

Matching Ferrule: N5300, N5400, N8000, S8000SM, S8900, S9000

Material : Carbon Steel, Stainless Steel

Specification: B5200 / ISO 12151-6

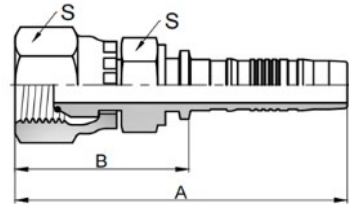

Part Number	Hose Size		Thread	A	B	W	S
	Inch	mm					
G-SERIES							
G04-04FBH	1/4	6.4	1/4-19	56	23	17	19
G06-06FBH	3/8	9.5	3/8-19	62.5	26	19	22
G08-08FBH	1/2	12.7	1/2-14	68	30	22	27
G10-10FBH	5/8	15.9	5/8-14	78	32	24	30
G12-12FBH	3/4	19	3/4-14	85	36	27	32
G16-16FBH	1	25.4	2-11	100	39	32	41
P-SERIES							
P12-12FBH	3/4	19	3/4-14	100	39	30	36
P16-16FBH	1	25.4	1-11	112	40	36	41

FB FEMALE BSP PARALLEL 60° CONE SWIVEL (BSPP)
Features

Matching Ferrule: N5300, N5400, N8000, S8000SM, S8900, S9000

Material : Carbon Steel, Stainless Steel

Specification: B5200 / ISO 12151-6

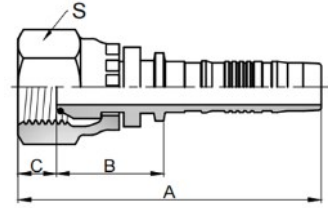

Part Number	Hose Size		Thread	A	B	C	S
	Inch	mm					
G-SERIES							
G04-02FB	1/4	6.4	1/8-28	50.5	4,3	17	14
G04-04FB	1/4	6.4	1/4-19	51.5	5,2	19	19
G04-06FB	1/4	6.4	3/8-19	54	6	20	22
G06-04FB	3/8	9.5	1/4-19	53	5.2	18	19
G06-06FB	3/8	9.5	3/8-19	57	6	20	22
G06-08FB	3/8	9.5	1/2-14	60	6.5	22	27
G08-06FB	1/2	12.7	3/8-19	59	6	21	19
G08-08FB	1/2	12.7	1/2-14	62	6.5	23	27
G08-10FB	1/2	12.7	5/8-14	66	9.7	23	30
G10-10FB	5/8	15.9	5/8-14	68	9.7	23	30
G10-12FB	5/8	15.9	3/4-14	71	8.7	27	32
G12-12FB	3/4	19	3/4-14	75.5	8.7	26	32
G12-16FB	3/4	19	1-11	76	10.5	35	41
G16-16FB	1	25.4	1-11	92	10.5	31	41
G20-20FB	1.1/4	31.8	1 1/4-11	100	10.1	32	50
G24-24FB	1.1/2	38.1	1 1/2-11	108.5	12.5	33	55
G32-32FB	2	50.8	2-11	122	16.1	37	70

P-SERIES

P12-12FB	3/4	19	3/4-14	90	8.7	29	32
P16-16FB	1	25.4	1-11	105	10.5	33	41
P20-20FB	1.1/4	31.8	1 1/4-11	120	10.1	34	50
P24-24FB	1.1/2	38.1	1 1/2-11	128	12.5	40	55
P32-32FB	2	50.8	2-11	152	16.1	48	70

FB45 FEMALE BSP PARALLEL 60° CONE SWIVEL 45° ELBOW (BSPP)

Features

Matching Ferrule: N5300, N5400, N8000, S8000SM, S8900, S9000

Material : Carbon Steel, Stainless Steel

Specification: B5200 / ISO 12151-6

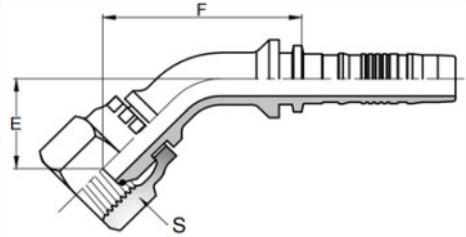

Part Number	Hose Size		Thread	E	F	S
	Inch	mm				

G-SERIES

G04-02FB45	1/4	6.4	1/8-28	16	40	14
G04-04FB45	1/4	6.4	1/4-19	16	40	19
G04-06FB45	1/4	6.4	1/4-19	16	40	22
G06-04FB45	3/8	9.5	1/4-19	18	47	19
G06-06FB45	3/8	9.5	3/8-19	18	47	22
G06-08FB45	3/8	9.5	1/2-14	20	48	27
G08-06FB45	1/2	12.7	3/8-19	20.5	53	19
G08-08FB45	1/2	12.7	1/2-14	20.5	53	27
G08-10FB45	1/2	12.7	5/8-14	22	53	30
G10-10FB45	5/8	15.9	5/8-14	24.5	60	30
G10-12FB45	5/8	15.9	3/4-14	26	64	32
G12-12FB45	3/4	19	3/4-14	27	70	32
G12-16FB45	3/4	19	1-11	29	75	41
G16-16FB45	1	25.4	1-11	33	87	41
G20-20FB45	1.1/4	31.8	1 1/4-11	41	108	50
G24-24FB45	1.1/2	38.1	1 1/2-11	46	138	55
G32-32FB45	2	50.8	2-11	57	170	70

P-SERIES

P12-12FB45	3/4	19	3/4-14	28	76	32
P16-16FB45	1	25.4	1-11	33	92	41
P20-20FB45	1.1/4	31.8	1 1/4-11	41	120	50
P24-24FB45	1.1/2	38.1	1 1/2-11	46	142	55
P32-32FB45	2	50.8	2-11	57	175	70

FB90 FEMALE BSP PARALLEL 60° CONE SWIVEL 90° ELBOW (BSPP)
Features

Matching Ferrule: N5300, N5400, N8000, S8000SM, S8900, S9000

Material : Carbon Steel, Stainless Steel

Specification: BS5200, ISO 12151-6

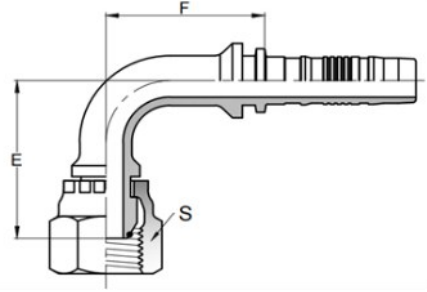
 PART D
G/P Series

Part Number	Hose Size		Thread	E mm	F mm	S mm
	Inch	mm				
G-SERIES						
G04-02FB90	1/4	6.4	1/8-28	26	25	14
G04-04FB90	1/4	6.4	1/4-19	27	25	19
G04-06FB90	1/4	6.4	3/8-19	31	30	22
G06-04FB90	3/8	9.5	1/4-19	34	36	19
G06-06FB90	3/8	9.5	3/8-19	34	36	22
G06-08FB90	3/8	9.5	1/2-14	38	36	27
G08-06FB90	1/2	12.7	3/8-19	40	45	19
G08-08FB90	1/2	12.7	1/2-14	40.5	45	27
G08-10FB90	1/2	12.7	5/8-14	42.5	45	30
G10-10FB90	5/8	15.9	5/8-14	47	46	30
G10-12FB90	5/8	15.9	3/4-14	48	53	32
G12-12FB90	3/4	19	3/4-14	55	58	32
G12-16FB90	3/4	19	1-11	54	60	41
G16-16FB90	1	25.4	1-11	66	76	41
G20-20FB90	1.1/4	31.8	1 1/4-11	85	93	50
G24-24FB90	1.1/2	38.1	1 1/2-11	96	113	55
G32-32FB90	2	50.8	2-11	120	136	70
P-SERIES						
P12-12FB90	3/4	19	3/4-14	55	60	32
P16-16FB90	1	25.4	1-11	66.5	76	41
P20-20FB90	1.1/4	31.8	1 1/4-11	85	97	50
P24-24FB90	1.1/2	38.1	1 1/2-11	96	118	55
P32-32FB90	2	50.8	2-11	120	145	70

FB90S FEMALE BSP PARALLEL 60° CONE SWIVEL 90° ELBOW - SHORT DROP

Features

Matching Ferrule: N5300, N5400, N8000, S8000S

Material : Carbon Steel, Stainless Steel

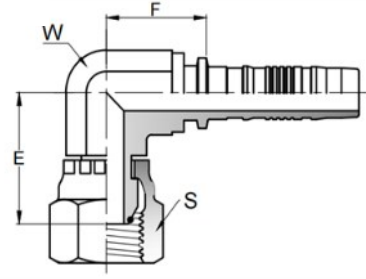

PART D
G/P Series

Part Number	Hose Size		Thread	E	F	W	S
	Inch	mm					

G-SERIES

G04-04FB90S	1/4	6.4	1/4-19	22.5	20	14	19
G06-06FB90S	3/8	9.5	3/8-19	25	22	16	22
G08-08FB90S	1/2	12.7	1/2-14	30	24	19	27
G10-10FB90S	5/8	15.9	5/8-14	32	26	22	30
G12-12FB90S	3/4	19	3/4-14	38	34	27	32
G16-16FB90S	2	50.8	2-11	42	49	33	41

FK FEMALE METRIC 30° FLARE SWIVEL (KOMATSU - DOUBLE HEX)
Features

Matching Ferrule: N5300, N5400, N8000, S8000SM, S8900, S9000

Material : Carbon Steel, Stainless Steel

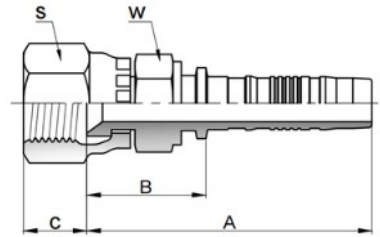
 PART D
G/P Series

Part Number	Hose Size		Thread metric	A mm	B mm	W mm	S mm
	Inch	mm					
G-SERIES							
G04-12FK-M1.0	1/4	6.4	M12x1.0	48	20	14	17
G04-12FK-M1.5	1/4	6.4	M12x1.5	48	20	14	17
G04-14FK	1/4	6.4	M14x1.5	50	22	17	19
G06-16FK	3/8	9.5	M16x1.5	55	25	19	22
G06-18FK	3/8	9.5	M18x1.5	55	25	19	24
G06-20FK	3/8	9.5	M20x1.5	56	26	22	27
G08-20FK	1/2	12.7	M20x1.5	58	25	22	27
G08-22FK	1/2	12.7	M22x1.5	58	25	22	27
G08-24FK	1/2	12.7	M24x1.5	58	25	24	30
G10-24FK	5/8	15.9	M24x1.5	64	29	24	30
G12-30FK	3/4	19	M30x1.5	68	32	27	36
G16-33FK	1	25.4	M33x1.5	79	36	32	41
P-SERIES							
P12-30FK	3/4	19	M30x1.5	86.5	35	30	36
P16-33FK	1	25.4	M33x1.5	97.5	38	36	41
P20-36FK	1.1/4	31.8	M36x1.5	118	45	46	46
P24-42FK	1.1/2	38.1	M42x1.5	125	50	50	55

FKC FEMALE METRIC 30° FLARE SWIVEL (KOMATSU - SINGLE HEX)

Features

Matching Ferrule: 5300N5300, N5400, N8000, S8000SM, S8900, S9000

Material : Carbon Steel, Stainless Steel

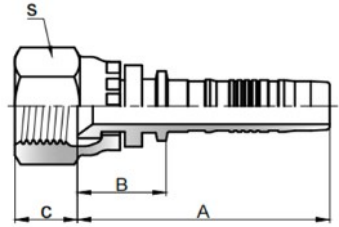

Part Number	Hose Size		Thread metric	A mm	B mm	S mm
	Inch	mm				
G-SERIES						
G04-12FKC-M1.0	1/4	6.4	M12x1.0	44	16	17
G04-12FKC-M1.5	1/4	6.4	M12x1.5	44	16	17
G04-14FKC	1/4	6.4	M14x1.5	44	16	19
G06-14FKC	3/8	9.5	M14x1.5	46	16	19
G06-16FKC	3/8	9.5	M16x1.5	47	17	22
G06-18FKC	3/8	9.5	M18x1.5	48	18	24
G06-20FKC	3/8	9.5	M20x1.5	49	19	27
G08-18FKC	1/2	12.7	M18x1.5	51	18	24
G08-20FKC	1/2	12.7	M20x1.5	51	18	27
G08-22FKC	1/2	12.7	M22x1.5	51	18	27
G08-24FKC	1/2	12.7	M24x1.5	55	22	30
G10-24FKC	5/8	15.9	M24x1.5	58	22	30
G12-30FKC	3/4	19	M30x1.5	63	22	32
G16-33FKC	1	25.4	M33x1.5	76	25	41
P-SERIES						
P12-30FK	3/4	19	M30x1.5	76	24	36
P16-33FK	1	25.4	M33x1.5	90	28	41
P20-36FK	1.1/4	31.8	M36x1.5	106	32	46
P24-42FK	1.1/2	38.1	M42x1.5	112	36	55

PART D
G/P Series

FK45 FEMALE METRIC 30° FLARE SWIVEL (KOMATSU) 45° ELBOW

Features

Matching Ferrule: N5300, N5400, N8000, S8000SM, S8900, S9000

Material : Carbon Steel, Stainless Steel

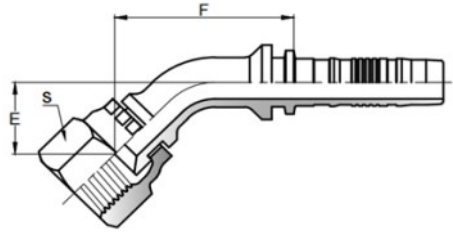

Part Number	Hose Size		Thread metric	E mm	F mm	S mm
	Inch	mm				
G-SERIES						
G04-12FK45-M1.0	1/4	6.4	M12x1.0	15	38	17
G04-12FK45-M1.5	1/4	6.4	M12x1.5	15	38	17
G04-14FK45	1/4	6.4	M14x1.5	15	38	19
G06-18FK45	3/8	9.5	M18X1.5	16	42	24
G08-22FK45	1/2	12.7	M22x1.5	19	58	27
G10-24FK45	5/8	15.9	M24x1.5	21	60	30
G12-30FK45	3/4	19	M30x1.5	25	70	36
G16-33FK45	1	25.4	M33x1.5	30	85	41
P-SERIES						
P12-30FK45	3/4	19	M30x1.5	25	70	36
P16-33FK45	1	25.4	M33x1.5	30	86	41

PART D
G/P Series

FK90 FEMALE METRIC 30° FLARE SWIVEL (KOMATSU) 90° ELBOW

Features

Matching Ferrule: N5300, N5400, N8000, S8000SM, S8900, S9000

Material : Carbon Steel, Stainless Steel

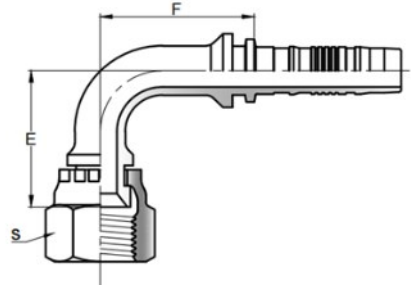

Part Number	Hose Size		Thread metric	E mm	F mm	S mm
	Inch	mm				

G-SERIES

G04-12FK90-M1.0	1/4	6.4	M12x1.0	24	27	17
G04-12FK90-M1.5	1/4	6.4	M12x1.5	24	27	17
G04-14FK90	1/4	6.4	M14x1.5	24	27	19
G06-18FK90	3/8	9.5	M18x1.5	28	32	24
G08-22FK90	1/2	12.7	M22x1.5	34	41	27
G10-24FK90	5/8	15.9	M24x1.5	41	45	30
G12-30FK90	3/4	19	M30x1.5	52	58	36
G16-33FK90	1	25.4	M33x1.5	63	74	41

P-SERIES

P12-30FK90	3/4	19	M30x1.5	55	60	36
P16-33FK90	1	25.4	M33x1.5	70	78	41

FJIS FEMALE JIS 30° FLARE SWIVEL

Features

Matching Ferrule: N5300, N5400, N8000, S8000SM, S8900, S9000

Material : Carbon Steel, Stainless Steel

Specification: JIS B8363

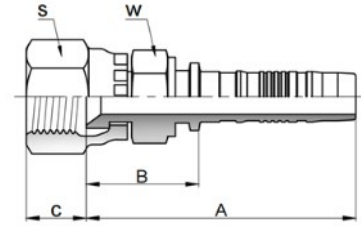

Part Number	Hose Size		Thread	A mm	B mm	C mm	S mm
	Inch	mm					
G-SERIES							
G04-04FJIS	1/4	6.4	1/4-19	50	22	14	19
G06-06FJIS	3/8	9.5	3/8-19	55	25	17	22
G08-08FJIS	1/2	12.7	1/2-14	59	26	22	27
G10-10FJIS	5/8	15.9	5/8-14	65	29	24	30
G12-12FJIS	3/4	19	3/4-14	68	32	27	32
G16-16FJIS	1	25.4	1-11	79	36	32	41
G20-20FJIS	1.1/4	31.8	1 1/4-11	93	43	41	50
G24-24FJIS	1.1/2	38.1	1 1/2-11	100	45	46	55
G32-32FJIS	2	50.8	2-11	110	52	60	70
P-SERIES							
P12-30FK	3/4	19	P12-12FJIS	86.5	35	30	36
P16-33FK	1	25.4	P16-16FJIS	97.5	38	36	41
P20-36FK	1.1/4	31.8	P20-20FJIS	118	45	46	50
P24-42FK	1.1/2	38.1	P24-24FJIS	125	50	50	60

FJIS45 FEMALE JIS 30° CONE SWIVEL 45° ELBOW

Features

Matching Ferrule: N5300, N5400, N8000, S8000SM, S8900, S9000

Material : Carbon Steel, Stainless Steel

Specification: JIS B8363

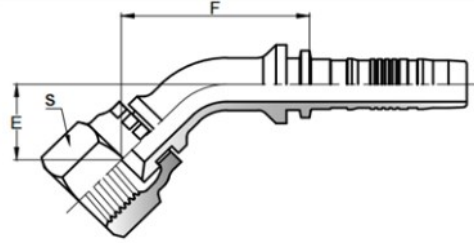

Part Number	Hose Size		Thread	E	F	S
	Inch	mm				
G-SERIES						
G04-04FJIS45	1/4	6.4	1/4-19	15	38	19
G06-06FJIS45	3/8	9.5	3/8-19	18	47	22
G08-08FJIS45	1/2	12.7	1/2-14	18	50	27
G10-10FJIS45	5/8	15.9	5/8-14	19	58	30
G12-12FJIS45	3/4	19	3/4-14	25	70	32
G16-16FJIS45	1	25.4	1-11	30	85	41
P-SERIES						
P12-12FJIS45	3/4	19	3/4-14	25	70	36
P16-16FJIS45	1	25.4	1-11	30	86	41

PART D
G/P Series

FJIS90 FEMALE JIS 30° CONE SWIVEL 90° ELBOW

Features

Matching Ferrule: 5300N5300, N5400, N8000, S8000SM, S8900, S9000

Material : Carbon Steel, Stainless Steel

Specification: JIS B8363

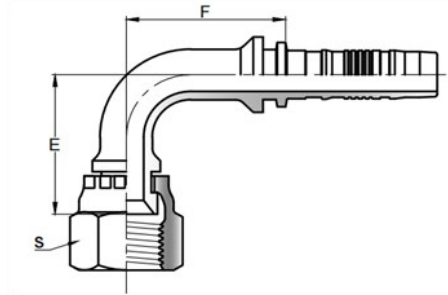

Part Number	Hose Size		Thread	E	F	S
	Inch	mm				
G-SERIES						
G04-04FJIS90	1/4	6.4	1/4-19	24	27	19
G06-06FJIS90	3/8	9.5	3/8-19	30	32	22
G08-08FJIS90	1/2	12.7	1/2-14	34	47	27
G10-10FJIS90	5/8	15.9	5/8-14	42	50	30
G12-12FJIS90	3/4	19	3/4-14	52	58	32
G16-16FJIS90	1	25.4	1-11	62	74	41
P-SERIES						
P12-12FJIS90	3/4	19	3/4-14	52	60	36
P16-16FJIS90	1	25.4	1-11	70	78	41

PART D
G/P Series

MA MALE METRIC 90° FLARE (AIR BRAKE)

Features

Matching Ferrule: N5300, N5400, N8000, S8000SM

Material : Carbon Steel, Stainless Steel

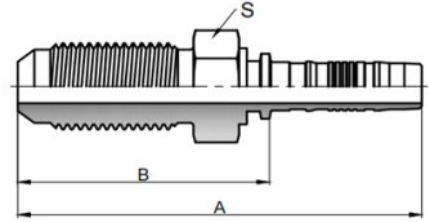

Part Number	Hose Size		Thread metric	A mm	B mm	S mm
	Inch	mm				
G-SERIES						
G04-12MA	1/4	6.4	M12x1.0	70	42	17
G04-14MA	1/4	6.4	M14x1.5	73	45	17
G04-16MA	1/4	6.4	M16x1.5	75	45	19
G06-14MA	3/8	9.5	M14x1.5	75	45	17
G06-16MA	3/8	9.5	M16x1.5	76	45	19
G06-18MA	3/8	9.5	M18x1.5	78	48	19
G06-20MA	3/8	9.5	M20x1.5	86	56	22
G08-20MA	1/2	12.7	M20x1.5	89	56	22
G08-22MA	1/2	12.7	M22x1.5	90	57	24

MAM MALE METRIC O-RING FACE SEAL

Features

Matching Ferrule: N5300, N5400, N8000, S8000SM

Material : Carbon Steel, Stainless Steel

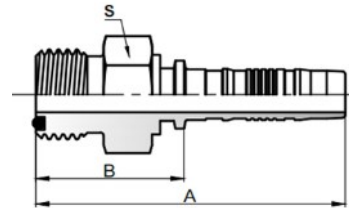

Part Number	Hose Size		Thread metric	A mm	B mm	S mm
	Inch	mm				
G-SERIES						
G12-32MAM	3/4	19	M32x1.5	76	36	32
G16-40MAM	1	25.4	M40x1.5	94	43	42

FA FEMALE METRIC FACE SEAL SWIVEL

Features

Matching Ferrule: N5300, N5400, N8000, S8000SM

Material : Carbon Steel, Stainless Steel



Part Number	Hose Size		Thread metric	A mm	B mm	S mm
	Inch	mm				
G-SERIES						
G04-14FA	1/4	6.4	M14x1.5	47	19	17
G04-16FA	1/4	6.4	M16x1.5	46	18	19
G04-18FA	1/4	6.4	M18x1.5	50	22	22
G06-18FA	3/8	9.5	M18x1.5	50	20	22
G06-22FA	3/8	9.5	M22x1.5	57	24	27
G08-22FA	1/2	12.7	M22x1.5	57	24	27
G10-27FA	5/8	15.9	M27x1.5	62	26	32
G12-30FA	3/4	19	M30x1.5	73	33	36
G12-36FA	3/4	19	M36x1.5	68	40	41
G16-36FA	1	25.4	M36x1.5	88	47	41

PART D
G/P Series

FA90 FEMALE METRIC O-RING FACE SEAL SWIVEL 90° ELBOW

Features

Matching Ferrule: N5300, N5400, N8000, S8000SM

Material : Carbon Steel, Stainless Steel

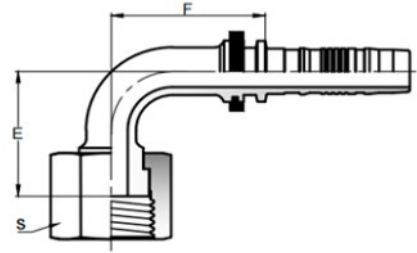

PART D
G/P Series

Part Number	Hose Size		Thread metric	E mm	F mm	S mm
	Inch	mm				
G-SERIES						
G04-14FA90	1/4	6.4	M14x1.5	24	34	17
G04-16FA90	1/4	6.4	M16x1.5	27	30	19
G06-18FA90	3/8	9.5	M18x1.5	29	40	22
G06-22FA90	3/8	9.5	M22x1.5	29	33	27
G08-22FA90	1/2	12.7	M22x1.5	30	37	27
G10-27FA90	5/8	15.9	M27x1.5	40	54	32
G12-30FA90	3/4	19	M30x1.5	48	60	36
G12-36FA90	3/4	19	M36x1.5	52	65	41
G16-36FA90	1	25.4	M36x1.5	57	76	41

MDK MALE METRIC 24° SWIVEL (KOBELCO)

Features

Matching Ferrule: N5300, N5400, N8000, S8000SM

Material : Carbon Steel, Stainless Steel

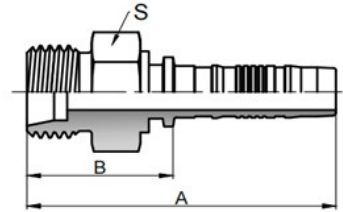

Part Number	Hose Size		Thread metric	A mm	B mm	S mm
	Inch	mm				
G-SERIES						
G12-30MDK	3/4	19	M30x1.5	77	37	32
G12-36MDK	3/4	19	M30x1.5	80	40	38
G16-36MDK	1	25.4	M36x1.5	92	41	41
G16-45MDK	1	25.4	M45x1.5	92	41	46

PART D
G/P Series

FDK FEMALE METRIC BALL NOSE SWIVEL (KOBELCO)

Features

Matching Ferrule: N5300, N5400, N8000, S8000SM

Material : Carbon Steel, Stainless Steel

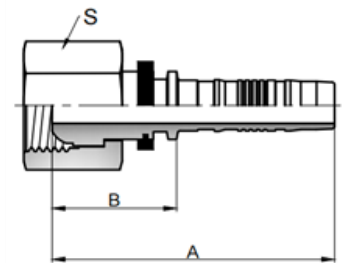

Part Number	Hose Size		Thread metric	A mm	B mm	S mm
	Inch	mm				
G-SERIES						
G12-30FDK	3/4	19	M30x1.5	70	30	36
G12-36FDK	3/4	19	M30x1.5	72	32	41
G16-36FDK	1	25.4	M36x1.5	86	45	41
G16-45FDK	1	25.4	M45x1.5	90	40	50

FDK90 – FEMALE METRIC BALL NOSE (KOBELCO) 90° ELBOW

Features

Matching Ferrule: N5300, N5400, N8000, S8000SM

Material : Carbon Steel, Stainless Steel

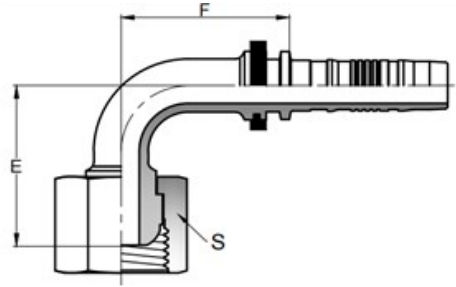

Part Number	Hose Size		Thread metric	E mm	F mm	S mm
	Inch	mm				
G-SERIES						
G12-30FDK90	3/4	19	M30x1.5	55	58	36
G12-36FDK90	3/4	19	M30x1.5	60	58	41
G16-36FDK90	1	25.4	M36x1.5	66	76	41
G16-45FDK90	1	25.4	M45x1.5	70	76	50

FD – FEMALE METRIC BALL NOSE SWIVEL

Features

Matching Ferrule: N5300, N5400, N8000, S8000SM

Material : Carbon Steel, Stainless Steel

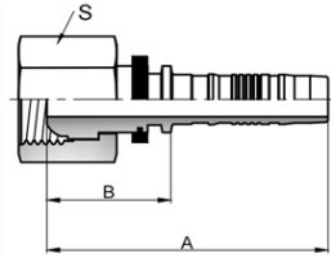

Part Number	Hose Size		Thread metric	A mm	B mm	S mm
	Inch	mm				
G-SERIES						
G04-14FD	1/4	6.4	M14x1.5	50	22	17
G04-16FD	1/4	6.4	M16x1.5	50	22	19
G06-16FD	3/8	9.5	M16x1.5	53	23	19
G06-18FD	3/8	9.5	M18x1.5	55	25	22
G06-20FD	3/8	9.5	M20x1.5	52.5	22.5	24
G08-20FD	1/2	12.7	M20x1.5	57	24	24
G08-22FD	1/2	12.7	M22x1.5	57	24	27
G10-27FD	5/8	15.9	M27x1.5	62	26	32
G12-30FD	3/4	19	M30x1.5	70	30	36
G16-36FD	1	25.4	M36x1.5	86	45	41
G16-38FD	1	25.4	M38x1.5	86	45	46

FD90 FEMALE METRIC BALL NOSE SWIVEL 90° ELBOW

Features

Matching Ferrule: N5300, N5400, N8000, S8000SM

Material : Carbon Steel, Stainless Steel

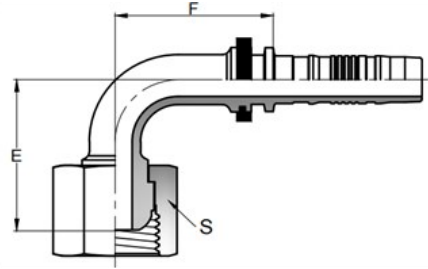

PART D
G/P Series

Part Number	Hose Size		Thread metric	E mm	F mm	S mm
	Inch	mm				
G-SERIES						
G04-14FD90	1/4	6.4	M14x1.5	28	29	17
G04-16FD90	1/4	6.4	M16x1.5	28	29	19
G06-16FD90	3/8	9.5	M16x1.5	35	30	19
G06-18FD90	3/8	9.5	M18x1.5	32	40	22
G06-20FD90	3/8	9.5	M20x1.5	32	40	24
G08-20FD90	1/2	12.7	M20x1.5	36	42	24
G08-22FD90	1/2	12.7	M22x1.5	38	45	27
G10-27FD90	5/8	15.9	M27x1.5	45	50	32
G12-30FD90	3/4	19	M30x1.5	54	60	36
G16-36FD90	1	25.4	M36x1.5	66	76	41
G16-38FD90	1	25.4	M38x1.5	66	76	46

BJ METRIC BANJO

Features

Matching Ferrule: N5300, N5400, N8000, S8000SM

Material : Carbon Steel

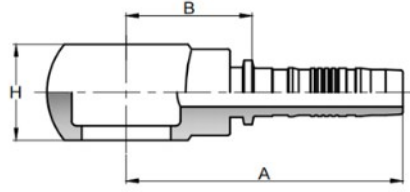

Part Number	Hose Size		Thread metric	A mm	B mm	H mm
	Inch	mm				
G-SERIES						
G04-10BJ	1/4	6.4	M10x1.0	50	22	10
G04-G12BJ	1/4	6.4	M12x1.5	50	22	12
G04-G12BJ-15.3	1/4	6.4	M12x1.5	53	25	15.3
G04-G12BJ-20	1/4	6.4	M12x1.5	53	25	20
G04-14BJ	1/4	6.4	M14x1.5	50	22	14
G04-16BJ	1/4	6.4	M16x1.5	53	25	16
G04-16BJ-15.3	1/4	6.4	M16x1.5	56	28	15.3
G04-16BJ-20	1/4	6.4	M16x1.5	56	28	20
G06-14BJ	3/8	9.5	M14x1.5	60	30	14
G06-16BJ	3/8	9.5	M16x1.5	56	26	16
G06-16BJ-15.3	3/8	9.5	M16x1.5	60	30	15.3
G06-16BJ-20	3/8	9.5	M16x1.5	60	30	20
G06-18BJ	3/8	9.5	M18x1.5	56	26	20
G06-20BJ	3/8	9.5	M20x1.5	60	30	22
G08-18BJ	1/2	12.7	M18x1.5	60	27	20
G08-20BJ	1/2	12.7	M20x1.5	63	30	22
G08-22BJ	1/2	12.7	M22x1.5	67	34	25
G10-26BJ	5/8	15.9	M26x1.5	72	36	30
G12-26BJ	3/4	19	M26x1.5	78	38	30

HM HOSE CONNECTOR

Features

Matching Ferrule: N5300, N5400, N8000, S8000SM, S8900, S9000

Material : Carbon Steel, Stainless Steel

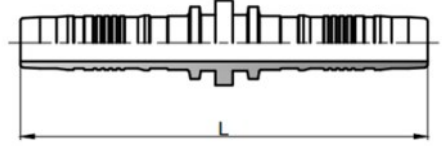

Part Number	Hose Size		L mm
	Inch	mm	
G-SERIES			
G04-04HM	1/4	6.4	70
G06-06HM	3/8	9.5	75
G08-08HM	1/2	12.7	82
G10-10HM	5/8	15.9	90
G12-12HM	3/4	19	100
G16-16HM	1	25.4	124
G20-20HM	1.1/4	31.8	140
G24-24HM	1.1/2	38.1	155
G32-32HM	2	50.8	168
P-SERIES			
P12-12HM	3/4	19	126
P16-16HM	1	25.4	148
P20-20HM	1.1/4	31.8	176
P24-24HM	1.1/2	38.1	185
P32-32HM	2	50.8	220

HW WELD FITTING

Features

Matching Ferrule: N5300, N5400, N8000, S8000SM

Material : Carbon Steel, Stainless Steel

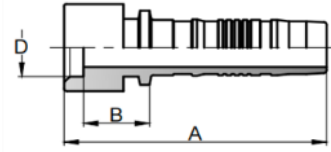

Part Number	Hose Size		A mm	B mm	D mm
	Inch	mm			
G-SERIES					
G04-04HW	1/4	6.4	42.5	10	6.5
G05-05HW	5/16	7.9	43	10	8.2
G06-06HW	3/8	9.5	45	10	10.2
G08-08HW	1/2	12.7	50	11	13
G10-10HW	5/8	15.9	56	14	16.5
G12-12HW	3/4	19	66	18	19.6
G16-16HW	1	25.4	80	18	26
G20-20HW	1.1/4	31.8	85	18	32.5
G24-24HW	1.1/2	38.1	92	18	38.5
G32-32HW	2	50.8	100	20	50

PART D
G/P Series

MPO MALE NPT PUSH-LOK FITTING

Features

Matching Ferrule: Nil

Material : Carbon Steel, Stainless Steel

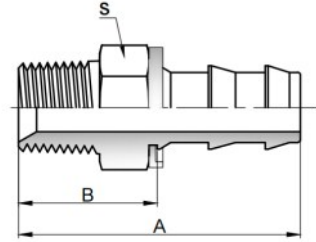

PART D
G/P Series

Part Number	Hose Size		Thread	A	B	S
	Inch	mm				
G-SERIES						
G04-02MPO	1/4	6.4	1/8-27	35	16	12
G04-04MPO	1/4	6.4	1/4-18	40	21	14
G04-06MPO	1/4	6.4	3/8-18	42	22	19
G06-04MPO	3/8	9.5	1/4-18	45	22	17
G06-06MPO	3/8	9.5	3/8-18	45	22	19
G06-08MPO	3/8	9.5	1/2-14	52	29	22
G08-06MPO	1/2	12.7	3/8-18	49	22	19
G08-08MPO	1/2	12.7	1/2-14	55	29	22
G12-12MPO	3/4	19	3/4-14	66	29	27
G16-16MPO	1	25.4	1-11.5	78	41	35

FJO FEMALE JIC 37° FLARE SWIVEL

Features

Matching Ferrule: Nil

Material : Carbon Steel, Stainless Steel

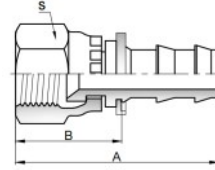

Part Number	Hose Size		Thread	A	B	W
	Inch	mm				
G-SERIES						
G04-04FJO	1/4	6.4	7/16x20	39	20	14.3
G04-05FJO	1/4	6.4	1/2x20	40	21	17
G04-06FJO	1/4	6.4	9/16x18	41	22	19
G06-06FJO	3/8	9.5	9/16x18	44	22	19
G06-08FJO	3/8	9.5	3/4x16	47	25	22
G08-08FJO	1/2	12.7	3/4x16	51	25	22
G08-10FJO	1/2	12.7	7/8x14	54	28	27
G10-10FJO	5/8	15.9	7/8x14	65	28	27
G12-12FJO	3/4	19	1.1/16x12	67	30	32
G16-16FJO	1	25.4	1.5/16x12	70	34	38

FJO90 FEMALE JIC 37° FLARE SWIVEL 90° ELBOW

Features

Matching Ferrule: Nil

Material : Carbon Steel, Stainless Steel

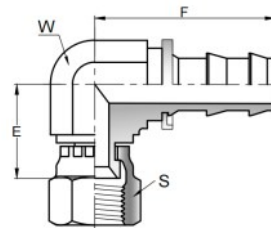

Part Number	Hose Size		Thread	E	F	S
	Inch	mm				
G-SERIES						
G04-04FJO90	1/4	6.4	7/16x20	17	38	14.3
G06-06FJO90	3/8	9.5	9/16x18	22.5	40	19
G08-08FJO90	1/2	12.7	3/4x16	25	44	22
G10-10FJO90	5/8	15.9	7/8x14	29	50	27
G12-12FJO90	3/4	19	1.1/16x12	31	60	32